



<b>Forest Carbon Partnership Facility (FCPF) Carbon Fund</b>	
<b>ER Monitoring Report (ER-MR)</b>	
<b>ER Program Name and Country:</b>	Zambézia Integrated Landscape Management Program (ZILMP) Republic of Mozambique
<b>Reporting Period covered in this report:</b>	01-01-2019 to 31-12-2020
<b>Number of FCPF ERs:</b>	483,756
<b>Quantity of ERs allocated to the Uncertainty Buffer</b>	131,336
<b>Quantity of ERs to allocated to the Reversal Buffer</b>	223,272
<b>Quantity of ERs to allocated to the Reversal Pooled Reversal buffer</b>	37,212
<b>Date of Submission:</b>	18-08-2022

**WORLD BANK DISCLAIMER**

The boundaries, colors, denominations, and other information shown on any map in ER-MR does not imply on the part of the World Bank any legal judgment on the legal status of the territory or the endorsement or acceptance of such boundaries.

The Facility Management Team and the REDD Country Participant shall make this document publicly available, in accordance with the World Bank Access to Information Policy and the FCPF Disclosure Guidance.

## TABLE OF CONTENTS

TABLE OF CONTENTS .....	3
1 IMPLEMENTATION AND OPERATION OF THE ER PROGRAM DURING THE REPORTING PERIOD.....	5
1.1 Implementation status of the ER Program and changes compared to the ER-PD .....	5
1.2 Update on major drivers and lessons learned .....	11
2 SYSTEM FOR MEASUREMENT, MONITORING AND REPORTING EMISSIONS AND REMOVALS OCCURRING WITHIN THE MONITORING PERIOD .....	12
2.1 Forest Monitoring System .....	12
2.2 Measurement, monitoring and reporting approach.....	17
3 DATA AND PARAMETERS .....	22
3.1 Fixed Data and Parameters.....	22
3.2 Monitored Data and Parameters .....	34
4 QUANTIFICATION OF EMISSION REDUCTIONS.....	42
4.1 ER Program Reference level for the Monitoring / Reporting Period covered in this report .....	42
4.2 Estimation of emissions by sources and removals by sinks included in the ER Program’s scope .....	42
4.3 Calculation of emission reductions .....	44
5 UNCERTAINTY OF THE ESTIMATE OF EMISSION REDUCTIONS .....	44
5.1 Identification, assessment and addressing sources of uncertainty.....	44
5.2 Uncertainty of the estimate of Emission Reductions.....	49
5.3 Sensitivity analysis and identification of areas of improvement of MRV system .....	52
6 TRANSFER OF TITLE TO ERS .....	52
6.1 Ability to transfer title .....	52
6.2 Implementation and operation of Program and Projects Data Management System .....	55
6.3 Implementation and operation of ER transaction registry .....	56
6.4 ERs transferred to other entities or other schemes.....	56
7 REVERSALS.....	56
7.1 Occurrence of major events or changes in ER Program circumstances that might have led to the Reversals during the Reporting Period compared to the previous Reporting Period(s) .....	56
7.2 Quantification of Reversals during the Reporting Period .....	57
7.3 Reversal risk assessment .....	58

8	EMISSION REDUCTIONS AVAILABLE FOR TRANSFER TO THE CARBON FUND .....	61
	ANNEX 1: INFORMATION ON THE IMPLEMENTATION OF THE SAFEGUARDS PLANS.....	63
	ANNEX 2: INFORMATION ON THE IMPLEMENTATION OF THE BENEFIT-SHARING PLAN.....	74
	ANNEX 3: INFORMATION ON THE GENERATION AND/OR ENHANCEMENT OF PRIORITY NON-CARBON BENEFITS .....	84
	ANNEX 4: CARBON ACCOUNTING - ADDENDUM TO THE ERPD.....	89
	ANNEX 5: ER MONITORING REPORT (ER-MR) ON THE AREA OUTSIDE THE SCOPE OF ZAMBÉZIA INTEGRATED LANDSCAPE MANAGEMENT PROGRAM (ZILMP) .....	90
5.1	CARBON POOLS, SOURCES AND SINKS .....	90
5.1.1	<b>Description of Sources and Sinks selected .....</b>	<b>90</b>
5.1.2	<b>Description of carbon pools and greenhouse gases selected .....</b>	<b>90</b>
5.2	REFERENCE LEVEL.....	90
5.2.1	<b>Reference Period .....</b>	<b>90</b>
5.2.2	<b>Forest definition used in the construction of the Reference Level .....</b>	<b>91</b>
5.2.3	<b>Average annual historical emissions over the Reference Period .....</b>	<b>91</b>
5.2.4	<b>Estimated Reference Level.....</b>	<b>107</b>
5.3	MONITORING AND REPORTING PERIOD.....	108
5.3.1	<b>Measurement, monitoring and reporting approach.....</b>	<b>108</b>
5.3.2	<b>Data and parameters.....</b>	<b>112</b>
5.4	QUANTIFICATION OF EMISSION REDUCTIONS .....	124
5.4.1	<b>Reference level for the Monitoring / Reporting Period covered in this report .....</b>	<b>124</b>
5.4.2	<b>Estimation of emissions by sources and removals by sinks included.....</b>	<b>124</b>
5.4.3	<b>Calculation of emission reductions .....</b>	<b>125</b>
5.5	UNCERTAINTY OF THE ESTIMATE OF EMISSION REDUCTIONS .....	126

# 1 IMPLEMENTATION AND OPERATION OF THE ER PROGRAM DURING THE REPORTING PERIOD

## 1.1 Implementation status of the ER Program and changes compared to the ER-PD

Unsustainable small-scale agriculture is the major driver of deforestation in Mozambique and within the Zambézia Emission Reduction (ER) Program. Illegal logging and informal charcoal production are the main drivers of forest degradation within the Program geographical area (Winrock International and CEAGRE, 2015 & Mercier et al., 2016). In order to address those drivers, the ER Program is based on a comprehensive approach that recognizes the link between agricultural development, natural resources management and governance. Since the ER Program only accounts for ERs resulting from reduced deforestation, activities focusing on the adoption of sustainable agricultural techniques will be key to its success. Nonetheless, the ER Program has four World Bank (WB) investment projects (the Agriculture and Natural Resources Landscape Management Project ([Sustenta](#)), Mozambique Conservation Areas for Biodiversity and Development Project ([MozBio](#)), Dedicated Grant Mechanism for Local Communities project ([MozDGM<sup>1</sup>](#)) and Forest Investment Project ([MozFIP](#))), and those have a broader approach on land management: their activities extend beyond the agricultural sector per se. This is actually coherent with the overall scheme of the ER Program, based on an integrated land management approach. Other measures focus on livelihood and income generation through the strengthening of key value chains of cash crops that are not responsible for deforestation, on regularizing land tenure and on community awareness to secure stakeholders' commitment on the long run. Regarding the Emission Reductions Program Document (ERPD) was prepared and this is financing more activities aiming to generate ERs within the ER Program.

### ***Crediting Period and Evidence of Implementation of Activities***

The Crediting Period for Zambézia Integrated Landscape Management Program is from January 1<sup>st</sup> 2018 to December 31<sup>st</sup> 2024.

According to the FCPF's (Forest Carbon Partnership Facility) *Glossary of Terms* ([link](#)) the Crediting Period Start Date has to comply with several conditions:

- i) it must not be earlier than the date of the first implementation of project activities;
- ii) is justified with objective evidence;
- iii) it cannot be earlier than January 1<sup>st</sup> 2016;
- iv) cannot fall within the Reference Period; and
- v) the activities must comply with safeguards requirements.

Table 1, which includes on-the-ground activities and enabling environment interventions for 3 of the projects: MozFIP<sup>2</sup>, MozBio<sup>3</sup> and Sustenta<sup>4</sup>. It can be seen that MozFIP continued the work on community delimitation and forest plantation scheme in 2019 and 2020. For Sustenta, Support to the development of agricultural and forestry value chains of the Project approved in 2019 and 2020 and new business plans for emerging small commercial farmers. Mozbio project initiated in 2015 and as can be seen in the 2017 and 2018 Project Activity Report, there were also some of activities on the ground in 2019 and 2020.

---

<sup>1</sup> (<https://mozdgm.org.mz/>)

<sup>2</sup> (<https://www.fnds.gov.mz/index.php/en/our-projects/project-list/MozFIP>)

<sup>3</sup> (<https://www.fnds.gov.mz/index.php/en/our-projects/project-list/mozbio>)

<sup>4</sup> (<https://www.fnds.gov.mz/index.php/en/resources/highlights/131-programa-sustenta-2>)

Compliance with safeguard requirements is described in detail in Annex 1: Information on the implementation of the Safeguards Plans.

Table 1: Specific project activities conducted in 2019 and 2020 in the ER Program Area.

Project	Activity	Evidence
MozFIP	Delimitation of communities	<p>2019 Project Activity Report:  <a href="https://www.dropbox.com/s/gibzegn2m4xjmjz/Relat%C3%B3rio%20Balan%C3%A7o%20Anual%20de%202019_APROVADO.docx?dl=0">https://www.dropbox.com/s/gibzegn2m4xjmjz/Relat%C3%B3rio%20Balan%C3%A7o%20Anual%20de%202019_APROVADO.docx?dl=0</a></p> <p>2020 Project Activity Report:  <a href="https://www.dropbox.com/s/ucm2kw2dvufwwp/Relat%C3%B3rio%20Anual%202020_FINAL.docx?dl=0">https://www.dropbox.com/s/ucm2kw2dvufwwp/Relat%C3%B3rio%20Anual%202020_FINAL.docx?dl=0</a></p> <p>Website from Service Provider with Results Dashboard  <a href="https://sites.google.com/site/verdeazullandscape/rduat">https://sites.google.com/site/verdeazullandscape/rduat</a></p>
	Forest Plantation Scheme (FPS)	<p>Contract with Consultant  <a href="https://www.dropbox.com/s/480cc7h8gai0g5y/Moz%20Agroforestry%20Contract%20signed.pdf?dl=0">https://www.dropbox.com/s/480cc7h8gai0g5y/Moz%20Agroforestry%20Contract%20signed.pdf?dl=0</a> and  <a href="https://www.dropbox.com/s/uowe3m4dourt04k/CONTRACTO%20HORFPEC.Lda.pdf?dl=0">https://www.dropbox.com/s/uowe3m4dourt04k/CONTRACTO%20HORFPEC.Lda.pdf?dl=0</a></p> <p>Proof of payment of consultants  <a href="https://www.dropbox.com/s/wdioc76k6ilfls/Horfpec%20--%20267.721%2C90.pdf?dl=0">https://www.dropbox.com/s/wdioc76k6ilfls/Horfpec%20--%20267.721%2C90.pdf?dl=0</a>  <a href="https://www.dropbox.com/s/mjbhdgcnjaq18zb/HORFPEC%20--299.776%2C14.pdf?dl=0">https://www.dropbox.com/s/mjbhdgcnjaq18zb/HORFPEC%20--299.776%2C14.pdf?dl=0</a></p> <p>Results of 2020/21 from Consultant NIRAS  <a href="https://www.dropbox.com/s/rbzj63pp35ujxpv/Apresenta%C3%A7%C3%A3o%20Missao%20WB%202021_v002.pdf?dl=0">https://www.dropbox.com/s/rbzj63pp35ujxpv/Apresenta%C3%A7%C3%A3o%20Missao%20WB%202021_v002.pdf?dl=0</a></p> <p>Proof of payment of consultants  <a href="https://www.dropbox.com/s/hqej2s1c5cywogz/Niras%207.945.959%2C96%2020111807444400.pdf?dl=0">https://www.dropbox.com/s/hqej2s1c5cywogz/Niras%207.945.959%2C96%2020111807444400.pdf?dl=0</a>  <a href="https://www.dropbox.com/s/uykep0lj97ifbv9/Niras%204500.000%2C00.pdf?dl=0">https://www.dropbox.com/s/uykep0lj97ifbv9/Niras%204500.000%2C00.pdf?dl=0</a></p> <p>Newsletter 2020/21  <a href="https://www.dropbox.com/s/sa97rb88vfi4ov0/_6%20edi%C3%A7%C3%A3o%20do%20Boletim%20Informativo%20do%20EFF%20e%20SAFs%20.pdf?dl=0">https://www.dropbox.com/s/sa97rb88vfi4ov0/_6%20edi%C3%A7%C3%A3o%20do%20Boletim%20Informativo%20do%20EFF%20e%20SAFs%20.pdf?dl=0</a></p>

	Capacity building for the local communities	<p>Report from capacity building for communities in management of natural resources (<a href="https://www.dropbox.com/s/6v0ve29d2dp6rco/Relatorio%20Final%20do%20Curso%20de%20Governanca%20e%20MCRN%20-%20Zambezia.docx.pdf?dl=0">https://www.dropbox.com/s/6v0ve29d2dp6rco/Relatorio%20Final%20do%20Curso%20de%20Governanca%20e%20MCRN%20-%20Zambezia.docx.pdf?dl=0</a>)</p> <p>Report from capacity building for communities in Nipiode and Anawape (<a href="https://www.dropbox.com/s/dk4fptc9iksmrww/Relat%C3%B3rio%20Final%20do%20curso%20de%20Fiscaliza%C3%A7%C3%A3o%20e%20Legisla%C3%A7%C3%A3o%20Florestal.pdf?dl=0">https://www.dropbox.com/s/dk4fptc9iksmrww/Relat%C3%B3rio%20Final%20do%20curso%20de%20Fiscaliza%C3%A7%C3%A3o%20e%20Legisla%C3%A7%C3%A3o%20Florestal.pdf?dl=0</a>)</p> <p>Finance administration training reports (<a href="https://drive.google.com/file/d/1UrX1vK5gG7qfPV0pcytBbW3zhGjf68yl/view">https://drive.google.com/file/d/1UrX1vK5gG7qfPV0pcytBbW3zhGjf68yl/view</a>)</p>
<b>Sustenta</b>	Agricultural development (16 SECF-Small emerging commercial farmers)	<p>Proof of payment (<a href="https://www.dropbox.com/s/bddinbe55om4y40/Paces.pdf?dl=0">https://www.dropbox.com/s/bddinbe55om4y40/Paces.pdf?dl=0</a>)</p>
	Restoration of degraded areas in the Sustenta Landscape	<p>Proof of payment (<a href="https://www.dropbox.com/s/gxktce3laksahvy/Factura.pdf?dl=0">https://www.dropbox.com/s/gxktce3laksahvy/Factura.pdf?dl=0</a>)</p> <p>2019 Project Activity Report (<a href="https://www.dropbox.com/s/dn9gw1afx7w82zr/Relat%C3%B3rio%20Anual%20de%20Actividades%202019vvvv_25.02.2020.doc?dl=0">https://www.dropbox.com/s/dn9gw1afx7w82zr/Relat%C3%B3rio%20Anual%20de%20Actividades%202019vvvv_25.02.2020.doc?dl=0</a>)</p> <p>2020 Project Activity Report (<a href="https://www.dropbox.com/s/6ve8du56uymy1gx/Relat%C3%B3rio%20Anual%20de%20Actividades%202020.%20PGIARN.versao%20final.1.doc?dl=0">https://www.dropbox.com/s/6ve8du56uymy1gx/Relat%C3%B3rio%20Anual%20de%20Actividades%202020.%20PGIARN.versao%20final.1.doc?dl=0</a>).</p>
	Support Micro, Small and Medium Enterprises to develop non-timber and non-wood forest products business plans	<p>2019 Project Activity Report (<a href="https://www.dropbox.com/s/t7cfifxvmue675a/Relatorio%20MozBio%201%202015-2019.pdf?dl=0">https://www.dropbox.com/s/t7cfifxvmue675a/Relatorio%20MozBio%201%202015-2019.pdf?dl=0</a>)</p> <p>2020 Project Activity Report (<a href="https://www.dropbox.com/s/75og5n9pxcv1sta/ANM%20-%20MozBio%20-%20Relat%C3%B3rio%20de%20actividades%202020%20-%20210526.pdf?dl=0">https://www.dropbox.com/s/75og5n9pxcv1sta/ANM%20-%20MozBio%20-%20Relat%C3%B3rio%20de%20actividades%202020%20-%20210526.pdf?dl=0</a>)</p>
<b>MozBio</b>	Community development projects	<p>2020 Project Activity Report (<a href="https://www.dropbox.com/s/75og5n9pxcv1sta/ANM%20-%20MozBio%20-%20Relat%C3%B3rio%20de%20actividades%202020%20-%20210526.pdf?dl=0">https://www.dropbox.com/s/75og5n9pxcv1sta/ANM%20-%20MozBio%20-%20Relat%C3%B3rio%20de%20actividades%202020%20-%20210526.pdf?dl=0</a>)</p> <p>Contract with Consultant (ETC) (<a href="https://www.dropbox.com/s/urrimrtzj9on1o/">https://www.dropbox.com/s/urrimrtzj9on1o/</a>)</p>

		<a href="#">Contracto%20ETCTERRA.pdf?dl=0</a>
		Proof of payment of consultants <a href="https://www.dropbox.com/s/jcmc5bsz4psbmmh/etc2.pdf?dl=0">https://www.dropbox.com/s/jcmc5bsz4psbmmh/etc2.pdf?dl=0</a> <a href="https://www.dropbox.com/s/rvy6pgbzw3goeed/etc3.pdf?dl=0">https://www.dropbox.com/s/rvy6pgbzw3goeed/etc3.pdf?dl=0</a>

### 1.1.1 Update on the strategy to mitigate and/or minimize potential Displacement.

The ER Program has done all efforts to minimize displacement of emissions to an area outside the Program boundaries and if present, it will be minimal, as most of the measures proposed to tackle the drivers of deforestation and forest degradation are primarily based on incentives and on the valorization of non-carbon benefits rather than coercive measures that will cause a displacement of drivers of deforestation. Therefore, the expectation is to lower the appeal of deforestation and forest degradation. As part of the strategy, the Monitoring, Report and Verification (MRV) Team developed a tool to detect annual deforestation for the whole country and currently, the data is accessible through the geospatial platform where deforestation for 2017, 2018, 2019 and 2020 in the Districts inside and outside of the ER Program and in other Provinces is displayed (See the link: <https://bit.ly/GeoportalmrvOnline>). Degradation is another component of forest monitoring that the MRV is developing (please see [Estimating emissions from degradation for ZILMP](#)). One major driver of deforestation identified during the design of the program was unsustainable small-scale agriculture and two causes of forest degradation identified are illegal logging and charcoal production. The drivers of deforestation and forest degradation within the ER Program remain the same (see section 1.2). All strategies outlined on the ER-PD are being strictly implemented to avoid displacement and the risk of displacement still assessed and categorized as low for slash and burn agriculture, low for charcoal production and Medium for Illegal logging (Table 2).

Table 2: Updates on strategies being applied to the different drivers of deforestation or degradation to minimize potential displacement.

Small scale agriculture based on “slash and burn” techniques	
Risk of displacement	Low
Progress of the strategy in Place	<p>There is a plan of involving 1500 farmers in technical assistance to adopt sustainable practices of agriculture such as Agroforest systems in about 750 ha. By the end of 2018, 550 farmers from Mulevala District (from 3 communities) were involved in a total area of 250ha. By 2020 the total area of agroforestry systems in the program area increased to a total of 931ha (click <a href="#">here</a> for more information).</p> <p>Community delimitation is the first step towards a sustainable management of natural resources and land. The outputs of community delimitations are Certificates signed by the Provincial Geography and Cadastral Service (SPGC), the community zoning Land Use map, the Community Land Use Plan and the Community development agenda. According to the ERPD plan, the aim is to achieve 322,500 ha of community land supported by land use plans by the end of the crediting period. Sustenta and MozFIP projects delimited a total of 187 communities land in Mulevala (48), Gilé (5), Mocubela (27), Gurue (4), Maganja da Costa (81) e Pebane (22) Districts. This number is expected to increase in the following years. This will reduce nomadism thus avoiding displacement. To foster sustainable community management, individual farmers also benefited from Regularization of the Right to Use and Benefit from Land (<i>Regularização do Direito de Uso e Aproveitamento da Terra</i> - R-DUAT) in Mocuba, Mulevala e Gilé 37,671 farmers, in an area of 60,559 ha. More details regarding R-DUATs can be found in <a href="#">Annex 3</a>.</p> <p>The District authorities are incentivizing the adoption of conservation agriculture practices to restore and maintain the soil fertility through public extension services. There are also</p>



	efforts to promote plantation of cashew trees as part of the agricultural extension package.
Charcoal production	
Risk of displacement	Low
Progress of the strategy in Place	The focus in this component is the training of charcoal makers to incentivize them to use fuel-efficient technology, promote the sustainable management of forests for charcoal production and use of forest logging and sawmill residues. 168 people from communities were trained to adopt improved kilns to produce charcoal in Pebane, Mocubela, Maganja da Costa and Ile. In each community, 500 hectares were identified for sustainable logging to produce charcoal. Four companies from the private sector were also involved in processing sawmill residues to produce charcoal. The use of sustainable charcoal in these communities is also happening and the private sector is in the process of adopting new practices of charcoal production. To ensure the value for money for charcoal production, informal partnership between the private sector and trained communities was established.
Unsustainable forestry practices, including illegal logging	
Risk of displacement	Medium
Progress of the strategy in Place	<p>The project is contributing significantly in strengthening the law enforcement in the forest sector. The Government moved this component from the National Directorate of Forest to the National Agency for Environmental Quality Control (AQUA). The support of the project was concentrated on the preparation of the strategy for law enforcement in forest, and investing on the creation of AQUA Delegation in Zambézia. MozFIP hired an international consultant to support AQUA in the production of the Law enforcement strategy.</p> <p>At the National level, by the recommendation of the last National Forestry Inventory (NFI), the Government of Mozambique (GoM) has recently taken strict actions over the most harvested tree species in Mozambique. For instance, harvesting of <i>Pterocarpus tinctorius</i> (Nkula), <i>Combretum imberbe</i> (Mondzo) and <i>Swartzia madagascariensis</i> (Pau-ferro) was banned as well exportation of <i>Pterocarpus angolensis</i> (Umbila), <i>Millettia stuhlmannii</i> (Jambirre, Panga-Panga), <i>Azelia quanzensis</i> (Chanfuta) in form of logs was ceased. <i>Swartzia madagascariensis</i> (Pau-ferro) occurs mostly within the Gilé National Park reason why the GoM decided to take such measures as the last NFI indicates that the species' stock has steeply declined over the past 10 years (<a href="https://fnds.gov.mz/mrv/index.php/documentos/relatorios/26-inventario-florestal-nacional/file">https://fnds.gov.mz/mrv/index.php/documentos/relatorios/26-inventario-florestal-nacional/file</a>).</p> <p>The GoM conducted a nation-wide audit of licensed areas (forest concessions and simple licenses) to assess the extent to which sustainable forest management practices are improving within the ER Program area and results have shown improvements. This assessment happens every two years since 2016.</p> <p>The GoM put in place a new law on timber exports, including log export ban on all native species to incentivize domestic timber processing for adding value to the product whilst also creating more jobs for rural communities</p> <p>A tool of Minimum standards for sustainable management was developed in 2018, to translate into a legal instrument for evaluation of operators' performance to inform any suspension of licenses, with potential for a national certification standard to be developed.</p> <p>In 2018 additional forest inventory plots were sampled in Zambézia, which improved the biomass estimates (<a href="#">link</a>) and was a critical input to the measures taken by the ministry regarding species exploitation and exportation ban.</p>

### 1.1.2 **Effectiveness of the organizational arrangements and involvement of partner agencies**

The success of implementation of an ER program is dependent on the stakeholder engagement. The ER Program has been inclusive on all the decisions regarding interventions on the ground aiming to generate ERs. The major milestones achieved are:

- The creation of a multi-stakeholder landscape forum for sustainable management of natural resources, which is a crucial instrument for stakeholder's consultation and participation in the implementation of the activities within the ER Program. This forum involves different civil society organizations; the Government; Private sector; community organizations and academic institutions. The connection to the platform has been very positive and active. In December 2019, the most recent version of the Benefit Sharing Plan (BSP) was subject to discussion and consultation, at a meeting held in Quelimane.
- Creation of a committee for assessing the implementation of forest plantation scheme (Composed by National Directorate of Agriculture and Forestry (DINAS), National Directorate of Forest (DINAF) and Manica Forestry Industries (IFLOMA). This committee has the role of Assess and approve the conformance and eligibility of the proposals to the signature of contracts; Approve payments to beneficiaries of the projects; Monitor progress of the implementation of the scheme. With a committee, performance evaluation of forest plantations was carried out for all beneficiaries of the Forest Plantation Scheme (FPS), showing maintenance rates of the planted area that varies between 70 and 98%. As a result, subsidy payments were made, with the first installment (new beneficiaries) and the second installment (former beneficiaries)<sup>5</sup>.
- Exchange of experience with New Forests Company (NFC) and World Wildlife Fund (WWF) Uganda with the support of NGP (New Generation Plantation) in how to engage the SME in forest plantations. A study visits and technological exchange was held in Uganda, which had as its main theme: "Sustainable Plantations for the Prosperity of Africa and was focused on the challenges and opportunities faced by forest companies in establishing sustainable plantations. This event was co-organized by NFC and WWF-Uganda with the support of the New Generation Plantations (NGP) Platform -. The Travel Report was shared with the World Bank.<sup>6</sup> Partnership between private sector and communities in small business enterprises (Sustainable charcoal production; non-timber forest products; community concessions, among others).
- Several Memoranda of Understanding (MoU) were signed between Community-Based Organizations (CBOs) and private sector, such as: MoU between Mocuba Honey Company and the associations of Nipiode and Uapé was signed, with a view to making the honey business viable. The National Fund for Sustainable Development (FNDS) promoted a new negotiation process for the partnership to make the mushroom business viable with the Divateches-Agri and Miruku consortium, having already signed the MoU. Some negotiations have not been successful, but efforts are still being made to promote more partnerships.
- Regarding to the MoU between FNDS, Portucel and Niras, it was signed in 2020 (more details please click [here](#)). On the ground Portucel and Niras to supply seedling for MozFIP and provide technical assistance to the PFGS beneficiaries. There are important activities taking place, such as: i) providing seedlings and other

---

<sup>5</sup> Source: MozFIP annual progress report 2020 ([https://www.dropbox.com/s/n49lg01rpouw836/Relat%C3%B3rio%20Anual%202020\\_FINAL.docx?dl=0](https://www.dropbox.com/s/n49lg01rpouw836/Relat%C3%B3rio%20Anual%202020_FINAL.docx?dl=0))

<sup>6</sup> Source: MozFIP annual progress report 2018 (<https://www.fnds.gov.mz/index.php/en/our-projects/project-list/MozFIP>)

inputs at a subsidized price; ii) technical assistance; and iii) Training for extension technicians (please see [2019](#) and [2020](#) MozFIP reports for more details).

- The signature of the MoU between FNDS and Zambeze University (Unizambeze), to provide technical support for research and development; Supply interns (students) to help communities on the ground to comply with sustainable practices aiming to halt deforestation. The MoU has not yet been signed, but several activities are already underway, such as Unizambeze's involvement in the Forest Plantation Scheme, helping the NIRAS Service Provider and Portucel, during forestry operations.

The major milestones still to be achieved are:

- Finalize the land regularization process in Maganja da Costa and Pebane districts;
- Insert information from unofficial certificates, Community Land Use Plans (*Planos Comunitários de Uso de Terra* PCUT) and DUATs elaborated throughout the project, in the geospatial platform;
- Promote training and technical demonstrations of planting associated with greater frequency of technical assistance to beneficiaries as well as exchange of experience between various stakeholders;
- Continue aerial monitoring in the areas of Forest Plantation Scheme beneficiaries via drones with the aim of evaluating the progress of tree cover;
- Test participatory MRV process in others communities, in order to involve all actors, such as communities, civil society, private and public sector, in the assessment of deforestation and forest degradation. Therefore, capacity must be built at the level of provinces, districts and communities and training of community technicians.

## 1.2 Update on major drivers and lessons learned

Unsustainable small-scale agriculture still by far, the first driver of deforestation in the ER Program area. The data showed clearly that more than 70% of the changes detected were due to unsustainable small-scale agriculture both in the ER program area and outside (Winrock International and CEAGRE, 2015 & Mercier et al., 2016). Other drivers such as forest activities for timber and charcoal could not be detected directly as drivers. The solution is to improve the tool to detect the forest degradation which combines with updated high-resolution imagery or/and field survey.

The charcoal production process is a result of agriculture expansion and small agriculturalists maximizing value from the land clearing process. As evidence, during the site visit as part of 2<sup>nd</sup> verification of this monitoring report, the VVB team assured that expanding subsistence agriculture is the primary driver of deforestation. The VVB had the opportunity to interview numerous small formers during the site visit and is reasonably assured that expanding subsistence agriculture remains the primary driver of deforestation. On other hands in June of 2021 started a study that aims to analyze the driver, economic and cultural factors in deforestation and forest degradation. This study will bring a real and specific situation of driver of deforestation in Zambézia province and in the ER Program area.

Unsustainable timber exploitation poses a medium risk for potential displacement of the activity to the districts outside of the ER Program because law enforcement was intensified. However, such intensification had taken place throughout the country also, thus minimizing this potential risk. No harmful activities were prohibited inside of the ER Program as part of the strategies to minimize potential displacement; conversely, improvements on practices are based on incentives for agricultural intensification and settlement within the ER Program area through systematic land use delimitation and titling for individuals and communities. The integration of sustainable practices in forestry, agriculture and land use in the program area with involvement of different stakeholders using the participatory approach generated ERs for this monitoring/reporting period.

The risk of displacement is low as other Government initiatives are taking place on the other districts outside of the ER Program. For more information on the drivers of deforestation and forest degradation within the ER Program, kindly refer to the [Mozambique's ERPD](#). To sustain the generation of ERs in the program area and minimize the risk of displacement MozFIP will continue to monitor the dynamic of emissions from deforestation and forest degradation and invest in sustainable practices in agriculture, forestry and land.

## 2 SYSTEM FOR MEASUREMENT, MONITORING AND REPORTING EMISSIONS AND REMOVALS OCCURRING WITHIN THE MONITORING PERIOD

### 2.1 Forest Monitoring System

Mozambique has not formalized its national monitoring system (NFMS). There is a work in progress between the DINAF and FNDS and other relevant stakeholders to formalize the NFMS. This process started in 2019, with the establishment of the NFMS Task Force, responsible for designing, developing and operationalizing the NFMS. Technical officers of DINAF and FNDS (MRV unit) were appointed as its members.

The NFMS Working Group, as a group of stakeholders related to the NFMS with its role to provide related information, inputs and advice to the development and operationalization of the NFMS. The initial members included DINAF, National Directorate of Environment (DINAB), National Directorate of Land (DINAT), FNDS, Eduardo Mondlane University (UEM), Institute of Agricultural Research of Mozambique (IIAM), FAO (Food and Agriculture Organization of the United Nations), World Bank, International Union for Conservation of Nature (IUCN) and Federation of Timber Operators (AMOMA). However, the Working Group is, by its nature, an open forum which the members can change flexibly depending on the needs and interests.

The first version of the NFMS document was finalized in 2021 ([link](#)) and defines its NFMS as a system which enables accountable reporting of REDD+ results; monitoring the implementation and effectiveness of Policies and Measures (PaMs) for sustainable forest management which include national and international purposes and beyond REDD+; and builds on robust IT system to support data management and transparency. The following principles are stated in the document as the basis of the NFMS:

- The NFMS shall be designed and operationalized under the full ownership of Ministry of Land and Environment (MTA), and in collaboration with related stakeholders;
- The NFMS should be target-driven, oriented towards specified sub-national, national and international objectives;
- The NFMS shall build on existing system as far as practical;
- The NFMS shall be developed through step-wise improvement, take into consideration the national circumstances, reflect the phased approach for the implementation of REDD+ activities, and sustainable in the long-run. The development shall be realistically feasible within the available time, financial and human resources; and
- The NFMS shall meet the international requirement under REDD+, and as appropriate, apply international and national good practices.

The current monitoring system has three sub-systems:

- Satellite and land monitoring system
- National forest inventory
- National Greenhouse Gases (GHG) inventory

#### **Satellite and land monitoring system**

The satellite and monitoring system is a sub-system within the NFMS that produces the activity data. The MRV Unit within FNDS is responsible for this system. It specifically generates the information on the number of hectares of deforestation within a given geographic area. This system produced information of deforestation that was used to produce the ER Program's RL and the National Forest Reference Emissions Level (FREL). This information was also used to generate historical deforestation statistics for Provinces, districts ([link https://fnfs.gov.mz/mrv/index.php/documentos/estudos/15-anuario-ambiental-para-instituto-nacional-de-estatistica-ine/file](https://fnfs.gov.mz/mrv/index.php/documentos/estudos/15-anuario-ambiental-para-instituto-nacional-de-estatistica-ine/file)), conservation areas and Zambézia Integrated Landscape Management Program (ZILMP) using a systematic stratified sampling. With new tool to detect deforestation developed, it was possible to produce annual deforestation maps for 2017, 2018, 2019 and 2020 as shown in the link <https://bit.ly/GeoportalMRVOnline> for the whole country and the area estimates for Zambézia Province which are based on sampling. The MRV unit from FNDS is responsible to produce the activity data for the ZILMP as well as for the country, as it has gained experience and expertise from training provided with FCPF finance.

The process of generating activity data comprises five steps (Figure 5); they are *response design, map production, sampling design, data collection and analysis*. These steps mainly define the criteria for classification, produces a change map and area estimates.

To ensure a good quality of data the team developed and implemented Quality Assurance/Quality Control (QA/QC) processes in all production processes including the development of Standard Operating Procedures (SOPs). This ensures a high standard of quality of the data produced. To guarantee the replication of processes, the MRV unit developed a Portuguese version guideline to produce activity data, accessed through the link <https://fnfs.gov.mz/mrv/index.php/documentos/guioes/46-protocolo-de-monitoria-e-estimativa-de-emissoes-por-desmatamento-vjun2021/file>. Data collection is conducted by a core team of professional interpreters who work permanently for FNDS and who have received adequate training in the implementation of the SOPs.

To disseminate the use of activity data to communities and other stakeholders to monitor deforestation, the MRV unit started in December of 2020 to set up participatory MRV (PMRV) systems as described below ([Forest Monitoring System under the ZILMP](#)).

### **National forest Inventory**

The national forest inventory is the second sub-system within the NFMS, which produces the emission factors. They give the tonnage of carbon stored per unit hectare of forest. The tonnage of carbon per hectare varies from one type of forest to another. Mozambique has conducted four national forest inventories and the updating of NFI is carried out every 10 years. The information from these inventories were used to produce information for timber purposes. The last inventory in 2016-17 produced the emission factors used for the FREL submitted to the United Nations Framework Convention on Climate Change (UNFCCC) in 2018 (report may be accessed in the following link [https://redd.unfccc.int/files/moz\\_frel\\_report\\_final.v03\\_03102018.pdf](https://redd.unfccc.int/files/moz_frel_report_final.v03_03102018.pdf)). In order to have more accurate estimates for the ZILMP, the plots located in Zambézia Province were used to generate Specific Emission Factors for ZILMP. The methods to generate the emissions factors for ZILMP is described in the Zambézia forest inventory report: <https://fnfs.gov.mz/mrv/index.php/documentos/relatorios/41-relatorio-de-inventario-florestal-da-zambezia-actualizado/file>.

The process used to produce the emission factors followed these steps: Response design, Sampling design, Data collection and Data analysis (Details in Figure 5). The entity responsible for the National Forest Inventory is DINAF. The NFI report (<https://fnfs.gov.mz/mrv/index.php/documentos/relatorios/26-inventario-florestal-nacional/file>) was produced by FNDS and DINAF. The data collection involved the IIAM, the Faculty of Agronomy and Forest Engineering (FAEF), the Department of Biological Sciences and Provincial Forest Services. The estimation of emissions also relies on the allometric equations that have been developed by Masters and PhD students and research projects from FAEF and the Department of Biological Sciences (DCB) of the UEM.

To ensure the quality of the data collected, the team followed QAQC procedures defined by the National Directorate of Forest. To maintain the processes of the national forest inventory, the MRV unit developed a practical field manual for training teams in data collection that can be accessed on the link <https://fnfs.gov.mz/mrv/index.php/documentos/guioes/21-manual-do-inventario-florestal/file>.

The Permanent Sampling plots are another component of the National Forest Monitoring System that will improve the estimation of emissions factors and the IIAM leads the process. Currently, under the MozFIP project, a joint group of institutions that involves IIAM, FNDS, UEM and DINAF are establishing the network of Permanent Sampling plots across the country and in the Zambézia province particularly.

### **National GHG inventory**

The National GHG inventory for the purpose of REDD+ combines the Activity data and the emission factors (Figure 5) to estimate the annual emissions and the FREL.

At the national level, the recent experience of GHGs inventory was with the submission of the FRELS to the UNFCCC ( [https://redd.unfccc.int/files/moz\\_frel\\_report\\_final.v03\\_03102018.pdf](https://redd.unfccc.int/files/moz_frel_report_final.v03_03102018.pdf)). The National Directorate of Climate Change is responsible for the communication of GHG emissions of Mozambique, as the focal point for climate change with the UNFCCC. The National Directorate of Climate Change coordinates with DINAF and FNDS on the production of such information.

At the subnational level, the MRV unit from FNDS is currently responsible for the generation of all information related to emissions from deforestation for the ZILMP program and the national data, Provincial and District

FRELS. To maintain the quality standards in the production of emissions estimates from deforestation, the MRV unit has developed SOPs on how to produce the estimates.

Major institutional changes in institutional arrangements since the Approval of ERPD were: (1) Changes in the Ministries; (2) Change in the institutions. Before the approval of the ERPD, FNDS, DINAF, and the National Directorate of Environment was under the Ministry of Land, Environment and Rural Development (MITADER). IIAM was under the Ministry of Agriculture and Food Security (MASA); after the elections in 2019, the new Government was formed, and the result was the extinction of MITADER with the creation of Ministry of Land and Environment (MTA), the extinction of MASA with the creation of the Ministry of Agriculture and Rural Development (MADER). As a result, FNDS and IIAM were moved to MADER, while the National Directorate of Environment and DINAF moved to MTA. The climate change component of National Directorate of Environment was moved to a new Directorate, the National Directorate of Climate Change. This new setting is important as FNDS and DINAF now interact with the national Directorate of Climate Change on issues related to Reporting. Despite these changes on the institutional arrangements and lack of a formal institutional arrangement, the components of the Forest Monitoring System can deliver the function of producing the emissions from deforestation at all levels.

### ***Forest Monitoring System under the ZILMP***

The forest monitoring system (FMS) under the ZILMP is simpler in terms of processes and entities as it relies on the first and second system above and it is fully operated by the MRV unit within FNDS with collaboration of DINAF. Therefore, the system uses the standard technical procedures of the NFMS as required by Criterion 15 of the MF.

In December of 2020, the MRV Unit tested the introduction of participatory MRV (PMRV) for annual monitoring of deforestation under the ZILMP, which is part of the recommendation of civil society, decision makers and the scientific community in the measurement, reporting and verification (MRV) of stocks of carbon with the participation of the local community. In a first phase, the PMRV was tested in ten communities identified across the districts of Alto Molocué, Mocuba, Mulevala and Gilé, where three communities selected by district. The results of the PMRV test can be found on MRV website (PRMV page - <https://bit.ly/pmrvfndsredd>).

The main goal was to involve communities in deforestation reporting activities (confirming deforestation cases and reporting new cases in near-real time using GIS tools such as Survey123 for ArcGIS, ArcGIS Field Maps and ArcGIS Collector). During this expedition, meetings with community CGRN (Natural Resource Management Councils) were held to validate the deforestation map and to visit the field and identify the drives of deforestation.

Information on the ZILMP can be found both on the FCPF website (<https://www.forestcarbonpartnership.org/country/mozambique>) and the MRV Unit website (<https://www.fnds.gov.mz/mrv/>). The ERPD is available online on the FCPF website ([https://www.forestcarbonpartnership.org/system/files/documents/Mozambique\\_Revised%20ERPD\\_16April2018\\_CLEAN.pdf](https://www.forestcarbonpartnership.org/system/files/documents/Mozambique_Revised%20ERPD_16April2018_CLEAN.pdf)). The latest version of 2018 Monitoring Report is also available online, on the FCPF website (<https://www.forestcarbonpartnership.org/country/mozambique>) and on the MRV Unit website (<https://www.fnds.gov.mz/mrv/index.php/documentos/relatorios>).

The organogram of the MRV Unit responsible for the ZILMP monitoring is described in Figure 1. The MRV Unit was created in 2016, with a coordinator and 4 technicians (Alismo Herculano, Credêncio Maúnze, Délfio Mapsanganhe and Hercilo Odorico). Towards the end of 2016 a fifth element was added to the team (Muri Soares). In 2019 the unit added 3 new elements (Alex Boma, Orlando Macave and Sérgio João). Therefore, various efforts have been made in terms of personnel and resources in order to maintain the capacity of the MRV system to monitor and report emissions and emission reductions. The production of the various SOPs has contributed to the knowledge management of the MRV Unit. In addition, there is no task performed by only one person, which increases redundancy. The MRV Unit recognizes that there is a need for continuous improvement of its knowledge management process, to ensure that all activities are standardized and documented. The organizational structure for the Activity data (reference and annual) and NFI is described in Figure 2, Figure 3 and Figure 4.

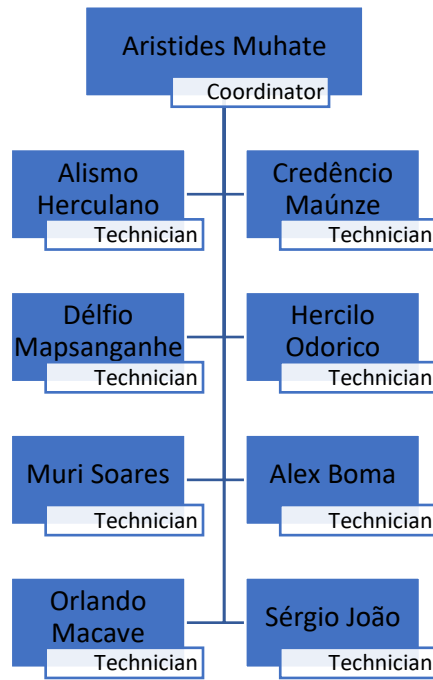

Figure 1: Organogram of MRV Unit responsible for ZILMP monitoring.

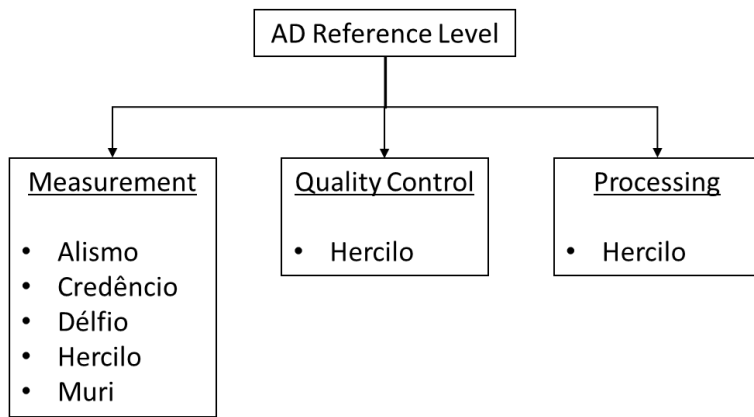

Figure 2: Organizational structure for Activity Data of Reference Level.

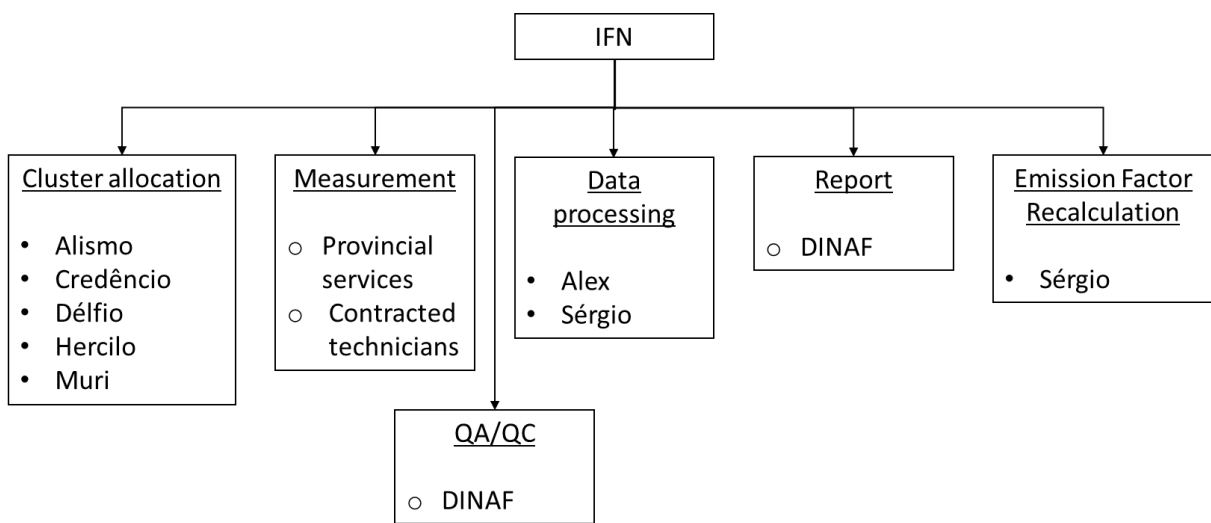

Figure 3: Organizational structure for National Forest Inventory.

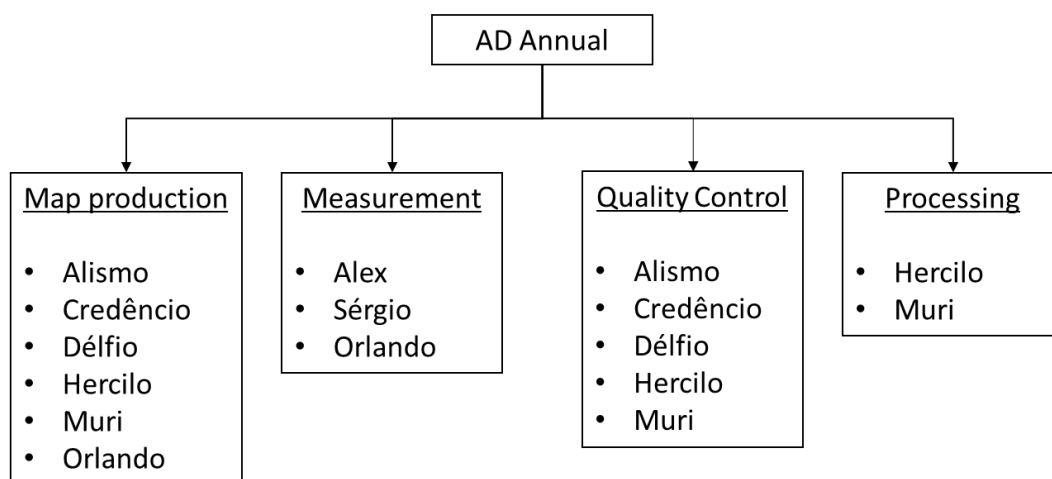

Figure 4: Organizational structure for Annual Activity Data.



i. **Systems and processes that support the Forest Monitoring System, including Standard Operating Procedures and QA/QC procedures;**

The developed SOPs are:

- Map production – SOP0
- Sampling Design – SOP1
- Response Design – SOP2
- Data Collection – SOP3
- Sample-based Area Estimation Analysis – SOP4

FNDS also has detailed QAQC procedures for the collection of reference data for the sample-based area estimation, which is described in the Standard Operating Procedures for Area Estimation document ([link](#)), which contains the above SOPs.

## **2.2 Measurement, monitoring and reporting approach**

### **2.2.1 Line Diagram**

The Figure 5 illustrates the emissions reductions calculation workflow during the Monitoring Period. It is important to note that as part of the ZILMP, all this workflow including the phase of reported is implemented by the MRV unit within FNDS.

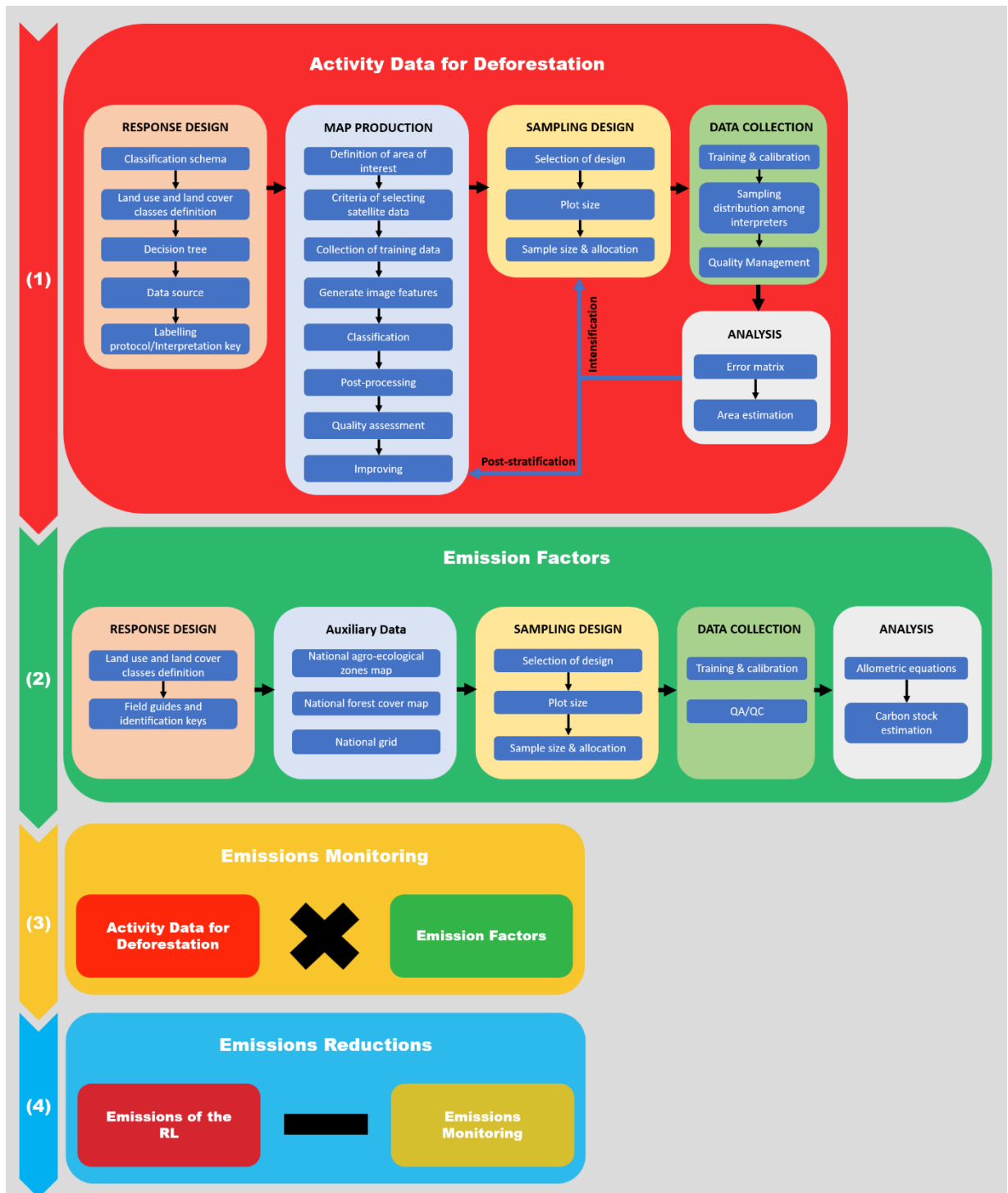

Figure 5: Emissions reductions calculation workflow.

### 2.2.2 Calculation

#### Emission reduction calculation

$$ER_{ERP,t} = RL_t - GHG_t \quad \text{Equation 1}$$

Where:

$ER_{ERP}$  = Emission Reductions under the ER Program in year t;  $tCO_2e \cdot year^{-1}$ .

$RL_{RP}$	=	Gross emissions of the RL from deforestation over the Reference Period; $tCO_2e*year^{-1}$ .
$GHG_t$	=	Monitored gross emissions from deforestation at year $t$ ; $tCO_2e*year^{-1}$ ;
$T$	=	Number of years during the monitoring period; <i>dimensionless</i> .

### Reference Level ( $RL_t$ )

Gross emissions of the RL from deforestation over the Reference Period ( $RL_{RP}$ ) are estimated as the sum of annual change in total biomass carbon stocks ( $\Delta C_{B_t}$ ) during the reference period.

$$RL_{RP} = \frac{\sum_t^{RP} \Delta C_{B_t}}{RP} \quad \text{Equation 2}$$

Where:

$\Delta C_{B_t}$	=	Annual change in total biomass carbon stocks at year $t$ ; $tC*year^{-1}$ ;
$RP$	=	Reference period; <i>years</i> .

Following the 2006 IPCC Guidelines, the annual change in total biomass carbon stocks forest land converted to other land-use category ( $\Delta C_{B_t}$ ) would be estimated through the following equation:

$$\Delta C_{B_t} = \Delta C_G + \Delta C_{CONVERSION} - \Delta C_L \quad \text{Equation 3}$$

Where:

$\Delta C_{B_t}$	Annual change of total biomass carbon stocks during the period, in tC per year;
$\Delta C_G$	Annual increase in carbon stocks in biomass due to growth on land converted to another land-use category, in tC per hectare and year;
$\Delta C_{CONVERSION}$	Initial change in carbon stocks in biomass on land converted to other land-use category, in tC per hectare and year; and
$\Delta C_L$	Annual decrease in biomass carbon stocks due to losses from harvesting, fuel wood gathering and disturbances on land converted to other land-use category, in tC per hectare and year.

Following the recommendations set in chapter 2.2.1 of the GFOI Methods Guidance Document for applying IPCC Guidelines and guidance in the context of REDD+<sup>7</sup>, the above equation will be simplified and it will be assumed that:

- The annual change in total biomass carbon stocks ( $\Delta C_B$ ) is equal to the initial change in carbon stocks ( $\Delta C_{CONVERSION}$ );

Considering equation 2.16 of the 2006 IPCC GL for estimating ( $\Delta C_{CONVERSION}$ ) the change of biomass carbon stocks could be expressed with the following equation:

$$\Delta C_{B_t} = \sum_{j,i} (B_{Before,j} - B_{After,i}) \times CF \times \frac{44}{12} \times A(j,i)_{RP} \quad \text{Equation 4}$$

Where:

$A(j,i)_{RP}$	Area converted/transited from forest type $j$ to non-forest type $i$ during the Reference Period, in <i>hectares per year</i> . In this case, three forest land conversions are possible: <ul style="list-style-type: none"> <li>• (Semi-)deciduous forest to Non-forest type <math>i</math>;</li> <li>• (Semi-)evergreen forest to Non-forest type <math>i</math>; and</li> </ul>
---------------	--

<sup>7</sup> [https://www.reddcompass.org/documents/184/0/MGD2.0\\_English/c2061b53-79c0-4606-859f-ccf6c8cc6a83](https://www.reddcompass.org/documents/184/0/MGD2.0_English/c2061b53-79c0-4606-859f-ccf6c8cc6a83)

- Mangrove forest to Non-forest type  $i$ .

Five types of non-forest land are considered:

- Cropland (C);
- Grassland (P);
- Wetland (A);
- Settlement (U); and
- Other lands (O).

$B_{Before,j}$  Total biomass of forest type  $j$  before conversion/transition, in tons of dry matter per ha. This is equal to the sum of aboveground ( $AGB_{Before,j}$ ) and belowground biomass ( $BGB_{Before,j}$ ) and it is defined for each forest type.

$B_{After,i}$  Total biomass of non-forest type  $i$  after conversion, in *tons dry matter per ha*. This is equal to the sum of aboveground ( $AGB_{After,i}$ ) and belowground biomass ( $BGB_{After,i}$ ) and it is defined for each of the five non-forest IPCC Land Use categories.

This parameter was technically corrected so as to replace the estimates sourced from research by estimates given by the 2006 IPCC Guidelines.

$CF$  Carbon fraction of dry matter in tC per ton dry matter. The value used is:

- **0.47** is the default for (sub)tropical forest as per IPCC AFOLU guidelines 2006, Table 4.3.

44/12 Conversion of C to CO<sub>2</sub>

### **Monitored emissions ( $GHG_t$ )**

Annual gross GHG emissions over the monitoring period in the Accounting Area ( $GHG_t$ ) are estimated as the sum of annual change in total biomass carbon stocks ( $\Delta C_{B_t}$ ).

$$GHG_t = \frac{\sum_t \Delta C_{B_t}}{T} \quad \text{Equation 5}$$

Where:

$\Delta C_{B_t}$  = Annual change in total biomass carbon stocks at year  $t$ ;  $tC \cdot year^{-1}$   
 $T$  = Number of years during the monitoring period; *dimensionless*.

### Changes in total biomass carbon stocks

Following the 2006 IPCC Guidelines, the annual change in total biomass carbon stocks forest land converted to other land-use category ( $\Delta C_B$ ) would be estimated through **Equation 3** above. Making the same assumptions as described above for the RL the change of biomass carbon stocks could be expressed with the following equation:

$$\Delta C_B = \sum_{j,i} (B_{Before,j} - B_{After,i}) \times CF \times \frac{44}{12} \times A(j,i)_{MP} \quad \text{Equation 6}$$

Where:

$A(j,i)_{MP}$  Area converted/transited from forest type  $j$  to non-forest type  $i$  during the Monitoring Period, in hectare per year. In this case, three forest land conversions are possible:

- (Semi-)deciduous forest to Non-forest type  $i$ ;
- (Semi-)evergreen forest to Non-forest type  $i$ ; and

- Mangrove forest to Non-forest type  $i$ .

Five types of non-forest land are considered:

- Cropland (C);
- Grassland (P);
- Wetland (A);
- Settlement (U); and
- Other lands (O).

These parameters may be found in [Section 3.2](#).

$B_{Before,j}$  Total biomass of forest type  $j$  before conversion/transition, in tons of dry matter per ha. This is equal to the sum of aboveground ( $AGB_{Before,j}$ ) and belowground biomass ( $BGB_{Before,j}$ ) and it is defined for each forest type.

This was defined ex-ante and is described in [Section 3.1](#).

$B_{After,i}$  Total biomass of non-forest type  $i$  after conversion, in *tons dry matter per ha*. This is equal to the sum of aboveground ( $AGB_{After,i}$ ) and belowground biomass ( $BGB_{After,i}$ ) and it is defined for each of the five non-forest IPCC Land Use categories.

This was defined ex-ante and is described in [Section 3.1](#).

$CF$  Carbon fraction of dry matter in tC per ton dry matter. The value used is:

- **0.47** is the default for (sub)tropical forest as per IPCC AFOLU guidelines 2006, Table 4.3.

44/12 Conversion of C to CO<sub>2</sub>

### 3 DATA AND PARAMETERS

#### 3.1 Fixed Data and Parameters

<b>Parameter:</b>	AGB <sub>before,j</sub>
<b>Description:</b>	Aboveground biomass of forest type <i>j</i> before conversion,
<b>Data unit:</b>	tons of dry matter per ha
<b>Source of data or description of the method for developing the data including the spatial level of the data (local, regional, national, international):</b>	<p>The data used for the present document are Tier 2 (country specific data or country level estimates or locally derived estimates) and they were sourced from the NFI (for deciduous and evergreen forests) or for Mangrove forests.</p> <p>For semi-deciduous and evergreen forest, the data are from the Zambézia Forest Inventory. It includes data that was collected in Zambézia province during the NFI, in 2017 and 2018. Although the inventory covers the whole Zambézia province (ER ZILMP program and outside). This is still representative of the forests located in the ZILMP as forests across the province are homogenous (floristic and structural composition). Moreover, the higher sample size of the forest inventory covering the whole province will enable more precise estimates for emission factors.</p> <p><i>i. Sampling design</i></p> <p>Carbon stocks before conversion for deciduous and evergreen forests were estimated using data from the National Forest Inventory sample units that were located in Zambézia province. The sample units for surveying carbon stocks were allocated using restricted stratified random sampling, using 4 * 4 km systematic grid superimposed on the agro-ecological zoning map, and stratified among the 12 forest types. Was considered as the strata, the semi-deciduous forest “open and closed”, Miombo forest “open and closed”, semi-evergreen forest “open and closed”, semi-evergreen MoUntain forest “open and closed”, Mopane forest “open and closed”, and Mecrusse forest “open and closed”, of which only the first eight types occur in Zambézia province.</p> <p>The total number of sample units was determined using the optimal allocation (assuming a maximum error of 10% for the total volume, and 5% of confidence level). Proportional allocation was used to determine the number of sample units per stratum (Husch, Beers, and Kershaw 2003). For Zambézia province, 128 clusters (512 plots) were distributed between the eight (8) forest types. The cluster was used as a sampling unit, and each cluster has 4 plots of 0.1 ha (20 * 50 m), where each plot was divided into 4 sub-plots of 0.025 ha (10 * 25 m) (Figure 6).</p>

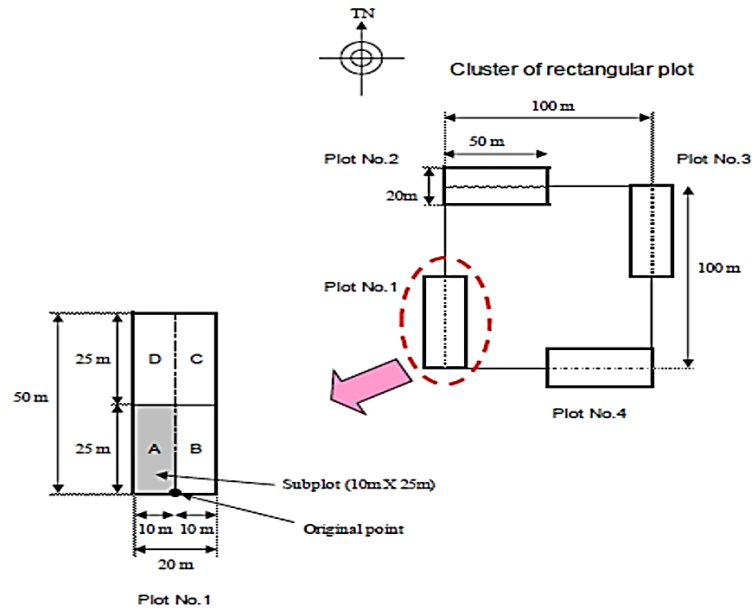

Figure 6: Design of each cluster used in the National Forest Inventory.

For estimating emission factors, the eight strata were aggregated into 2 (Semi-deciduous forest and semi-evergreen forest), and the similarity of the strata was used for the aggregation. The aggregation was done with the purpose of harmonizing the forest strata of the activity data with the emission factor data. Below the aggregation table.

Allocation stratum	EF Strata for MR
semi-deciduous open forest	semi-deciduous forest
semi-deciduous closed forest	
miombo open forest	
miombo closed forest	
semi-evergreen MoUntain open forest	semi-evergreen forest
semi-evergreen MoUntain closed forest	
semi-evergreen open forest	
semi-evergreen closed forest	

#### ii. Data collection

The plots were used for data collection of adult trees (diameter at breast height (dbh)  $\geq 10\text{cm}$ ), and the subplots "A" were used for data collection of established regeneration trees ( $10\text{cm} > \text{dbh} \geq 5\text{cm}$ ), which were included in the calculation of the carbon stocks. Data collected in the plots and subplots included tree information (dbh, scientific name, total and commercial height, stem quality), soil, forest type (this information was used to validate the information from agro-ecological zoning map), and other important information. Tree data were used to estimate above ground biomass (AGB) and below ground biomass (BGB).

The NFI did not cover Mangrove forests, so, data from the literature was used. For other strata, data from literature were also used.

Details of data collection can be found at <https://www.fnds.gov.mz/mrv/index.php/documentos/guioes/35-diretrizes-do-inventario-florestal-nacional/file>.

### iii. Prediction at plot level

Above ground biomass (AGB) and below ground biomass (BGB) were estimated using a series of allometric equations adjusted for ecosystems or tree species similar to those in the Zambézia province (Table 3), and this equation was applied at tree level.

The use of the equations meant, applying allometric equations of the specific species (*Millettia stuhlmannii* taub., *Pterocarpus angolensis* DC., *Azelia quanzensis* Welw.) in all trees of these species to estimate AGB, regardless of forest types. The allometric equation of the semi-deciduous forest was applied for all trees of this forest type (except the species mentioned above), as well as in all trees of the species *Brachystegia spiciformis* Benth., and *Julbernardia globiflora* (Benth.) Troupin to estimate AGB and BGB, because they were the main species used to adjust this equation in this forest type. The equations of the semi-evergreen forest were applied in all remaining trees of this forest type to estimate AGB; and apply the semi-deciduous forest equation in all trees to estimate the BGB in this forest type (including species mentioned above in other forest type), and apply factor 0.275 (shoot ratio) to estimate the BGB of the semi-evergreen forest.

Table 3: List of allometric equations used to estimate above and below biomass

Forest Type	Forest type or species	Above-ground biomass (AGB) [kg]	Below-ground biomass (BGB) [kg]
Semi-deciduous forest	Semi-deciduous forest (open and closed)	$\hat{Y} = 0.0763 * DAP^{2.2046} * H^{0.4918}$	$\hat{Y} = 0.1766 * DAP^{1.7844} * H^{0.3434}$
		Author: Mugasha <i>et al.</i> (2013)	Author: Mugasha <i>et al.</i> (2013)
	<i>Millettia stuhlmannii</i> taub.	$\hat{Y} = 5.7332 * DAP^{1.4567}$	$\hat{Y} = 0.1766 * DAP^{1.7844} * H^{0.3434}$
		Author: Mate <i>et al.</i> (2014)	Author: Mugasha <i>et al.</i> (2013)
	<i>Pterocarpus angolensis</i> DC.	$\hat{Y} = 0.2201 * DAP^{2.1574}$	$\hat{Y} = 0.1766 * DAP^{1.7844} * H^{0.3434}$
		Author: Mate <i>et al.</i> (2014)	Author: Mugasha <i>et al.</i> (2013)
<i>Azelia quanzensis</i> Welw.	$\hat{Y} = 3.1256 * DAP^{1.5833}$	$\hat{Y} = 0.1766 * DAP^{1.7844} * H^{0.3434}$	
	Author: Mate <i>et al.</i> (2014)	Author: Mugasha <i>et al.</i> (2013)	
Evergreen forest	Evergreen forest (open and closed)	$\hat{Y} = \exp(-2.289 + 2.649\ln(DAP) - 0.021(\ln(DAP))^2)$	$\hat{Y} = AGB * R/S; \quad R/S = 0.275$
		Author: IPCC (2003)	Author: Mokany <i>et al.</i> (2006)
		$\hat{Y} = 0.0613 * DAP^{2.7133}$	$\hat{Y} = AGB * R/S; \quad R/S = 0.275$



	Evergreen Mountain forest (open and closed)	Author: Lisboa <i>et al.</i> (2018)	Author: Mokany <i>et al.</i> (2006)							
	<i>Millettia stuhlmannii</i> taub.	$\hat{Y} = 5.7332 * DAP^{1.4567}$	$\hat{Y} = 0.1766 * DAP^{1.7844} * H^{0.3434}$							
		Author: Mate <i>et al.</i> (2014)	Author: Mugasha <i>et al.</i> (2013)							
	<i>Pterocarpus angolensis</i> DC.	$\hat{Y} = 0.2201 * DAP^{2.1574}$	$\hat{Y} = 0.1766 * DAP^{1.7844} * H^{0.3434}$							
		Author: Mate <i>et al.</i> (2014)	Author: Mugasha <i>et al.</i> (2013)							
	<i>Azelia quanzensis</i> Welw.	$\hat{Y} = 3.1256 * DAP^{1.5833}$	$\hat{Y} = 0.1766 * DAP^{1.7844} * H^{0.3434}$							
		Author: Mate <i>et al.</i> (2014)	Author: Mugasha <i>et al.</i> (2013)							
	<b>iv. Estimation</b>									
	<p>The estimation of mean and their respective uncertainties (standard error, sampling error, and confidence interval) for the variables biomass, carbon and carbon dioxide equivalent (above and below ground) for the two strata (semi-deciduous forest and semi-evergreen forest), were done using the forest inventory data analysis approach proposed by Bechtold &amp; Patterson (2005) chapter 4 of the book "The Enhanced Forest Inventory and Analysis Program-National Sampling Design and Estimation Procedures". Details of this methodology are described in Zambézia inventory report, available at <a href="https://fnds.gov.mz/mrv/index.php/documentos/relatorios/41-relatorio-de-inventario-florestal-da-zambezia-actualizado/file">https://fnds.gov.mz/mrv/index.php/documentos/relatorios/41-relatorio-de-inventario-florestal-da-zambezia-actualizado/file</a>.</p> <p>For mangrove forests, data are secondary, extracted from existing literature. Stringer <i>et al.</i> (2015)<sup>8</sup> made an inventory on this ecosystem in the Zambezi delta in Mozambique; we can easily assume that carbon stocks are comparable to those of mangroves in Zambézia province. They divided mangroves into 5 strata and estimated carbon stocks in above and belowground biomass. Since we do not have information on these specific strata for ZILMP, the mean and standard error of biomass (AGB and BGB) of mangrove forest, comes indirectly from table 1 of the article by Stringer <i>et al.</i> (2015). For its determination, first the mean of carbon was found for the two pools (sum of overstory and understory carbon) for each stratum (Height Class 1, ..., Height Class 5), followed by the calculation of the mean of the ecosystem (mean weighted according to the stratum areas). Finally, the carbon was converted to biomass using the conversion factor of 0.47 proposed in the IPCC good practice guide.</p> <p>Spatial level: Regional</p>									
	<b>Value applied:</b>	<table border="1"> <tr> <td>Semi-deciduous forest (FSD)</td> <td>144.69</td> </tr> <tr> <td>Evergreen forest (FSSV)</td> <td>123.13</td> </tr> <tr> <td>Mangrove forest (FF)</td> <td>269.01</td> </tr> </table>			Semi-deciduous forest (FSD)	144.69	Evergreen forest (FSSV)	123.13	Mangrove forest (FF)	269.01
	Semi-deciduous forest (FSD)	144.69								
	Evergreen forest (FSSV)	123.13								
Mangrove forest (FF)	269.01									

<sup>8</sup> Stringer, C. E.; Trettin, C. C.; Zarnoch, S. J. and Tang, W. 2015. Carbon stocks of mangroves within the Zambezi River Delta, Mozambique. *Forest Ecology Management* 354:139–148.

	The values above are estimated and extracted in the " <a href="#">Emission factor v.2</a> " workbook, and then they are recorded in the cells "B4", "B10" and "B16" respectively, of the "BIOMASS" worksheet tab in the " <a href="#">ZILMP Emissions Calculations MR (2019)</a> " and " <a href="#">ZILMP Emissions Calculations MR (2020)</a> " workbooks. These values are then applied in the range "C9:C20" of the "EMISSION MONITORING PERIOD(EMP)" worksheet tab in the " <a href="#">ZILMP Emissions Calculations MR (2019)</a> " and " <a href="#">ZILMP Emissions Calculations MR (2020)</a> " workbooks for estimating emissions.																													
<b>QA/QC procedures applied</b>	<p>The QA/QC procedures consisted on the following:</p> <ul style="list-style-type: none"> <li>• SOPs were developed as described in <i>Section 2.1 - National Forest Inventory</i>.</li> <li>• A training on the SOPs was conducted prior to the field work. This training lasted for 3 weeks, and consisted of training on the usage of all equipment and evaluating the specific skills of each participant, in order to determine the team and brigade leaders. On the start of the 2<sup>nd</sup> phase of the IFN (2017) an additional 1-week training was conducted, to refresh the participants and train any new members.</li> <li>• The supervisor of each inventory team conducted a remeasurement of 4 trees per plot which means 16 trees per cluster. This served to ensure that the SOPs were adequately implemented.</li> <li>• An independent measurement of 10% of the plots. This activity was conducted by technicians of the National Directorate of Forests, who had participated in the Provincial Inventories of Gaza and Cabo Delgado. Diameter error must be below 10%.</li> <li>• The adequacy of the allometric models, including root-to-shoot ratios used was confirmed by experts of the Faculty of Agronomy and Forest Engineering (FAEF) and the Department of Biology Sciences (DCB) of the Eduardo Mondlane University (UEM).</li> <li>• The World Bank conducted two regular supervision missions of the National Forest Inventories to confirm the adequate implementation of the SOPs and suggest areas for improvement. The report can be found <a href="#">here</a>.</li> <li>• An independent expert (Jim Alegria, ex-US Forestry Service) was hired in order to evaluate the methodology for the inventory and support in the estimation process, to address any gaps that were identified. The report can be found <a href="#">here</a>. Many of the issues identified in the report have since been corrected, with the help of the independent expert.</li> </ul>																													
<b>Uncertainty associated with this parameter:</b>	<table border="1"> <thead> <tr> <th rowspan="2">Forest type</th> <th colspan="5">Uncertainty estimate</th> </tr> <tr> <th>Mean</th> <th>Lower (5<sup>th</sup> percentile)</th> <th>Upper bound (95<sup>th</sup> percentile)</th> <th>Half-width confidence interval at 90%</th> <th>Relative Margin</th> </tr> </thead> <tbody> <tr> <td>FSD</td> <td>144.7</td> <td>116.7</td> <td>172.1</td> <td>27.7</td> <td>0.19</td> </tr> <tr> <td>FSSV</td> <td>123.1</td> <td>101.1</td> <td>145.1</td> <td>22</td> <td>0.18</td> </tr> <tr> <td>FF</td> <td>269</td> <td>225.1</td> <td>313.8</td> <td>44.35</td> <td>0.16</td> </tr> </tbody> </table>	Forest type	Uncertainty estimate					Mean	Lower (5 <sup>th</sup> percentile)	Upper bound (95 <sup>th</sup> percentile)	Half-width confidence interval at 90%	Relative Margin	FSD	144.7	116.7	172.1	27.7	0.19	FSSV	123.1	101.1	145.1	22	0.18	FF	269	225.1	313.8	44.35	0.16
Forest type	Uncertainty estimate																													
	Mean	Lower (5 <sup>th</sup> percentile)	Upper bound (95 <sup>th</sup> percentile)	Half-width confidence interval at 90%	Relative Margin																									
FSD	144.7	116.7	172.1	27.7	0.19																									
FSSV	123.1	101.1	145.1	22	0.18																									
FF	269	225.1	313.8	44.35	0.16																									
<b>Any comment:</b>	-																													

<b>Parameter:</b>	BGB <sub>before,j</sub>
<b>Description:</b>	Belowground biomass of forest type <i>j</i> before conversion,
<b>Data unit:</b>	tons of dry matter per ha
<b>Source of data or description of the method for developing the data</b>	<p>For semi-deciduous and evergreen forest, data are from the Zambézia Forest Inventory. It includes data that was collected in Zambézia province during the NFI, in 2017 and 2018. Please refer to parameter AGB<sub>before,j</sub> for more information on how the below ground biomass was estimated.</p> <p>For mangrove forests, please refer to parameter AGB<sub>before,j</sub> for more information.</p>

<b>including the spatial level of the data (local, regional, national, international):</b>	Spatial level: Regional																													
<b>Value applied:</b>	<table border="1"> <tr> <td>Semi-deciduous forest (FSD)</td> <td>49.95</td> </tr> <tr> <td>Evergreen forest (FSSV)</td> <td>42.06</td> </tr> <tr> <td>Mangrove forest (FF)</td> <td>85.43</td> </tr> </table> <p>The values above are estimated and extracted in the workbook "<a href="#">Emission factor v.2</a>", and then they are recorded in the cells "B34", "B40" and "B46" respectively, of the "BIOMASS" worksheet tab in the "<a href="#">ZILMP Emissions Calculations MR (2019)</a>" and "<a href="#">ZILMP Emissions Calculations MR (2020)</a>" workbooks. These values are then applied in the range "E9:E20" of the "EMISSION MONITORING PERIOD(EMP)" worksheet tab in the "<a href="#">ZILMP Emissions Calculations MR (2019)</a>" and "<a href="#">ZILMP Emissions Calculations MR (2020)</a>" workbooks for estimating emissions.</p>	Semi-deciduous forest (FSD)	49.95	Evergreen forest (FSSV)	42.06	Mangrove forest (FF)	85.43																							
Semi-deciduous forest (FSD)	49.95																													
Evergreen forest (FSSV)	42.06																													
Mangrove forest (FF)	85.43																													
<b>QA/QC procedures applied</b>	Please see section QA/QC procedures under parameter $AGB_{before,j}$ .																													
<b>Uncertainty associated with this parameter:</b>	<table border="1"> <thead> <tr> <th rowspan="2">Forest type</th> <th colspan="5">Uncertainty estimate</th> </tr> <tr> <th>Mean</th> <th>Lower (5<sup>th</sup> percentile)</th> <th>Upper bound (95<sup>th</sup> percentile)</th> <th>Half-width confidence interval at 90%</th> <th>Relative Margin</th> </tr> </thead> <tbody> <tr> <td>FSD</td> <td>49.9</td> <td>41.5</td> <td>58.4</td> <td>8.4</td> <td>0.17</td> </tr> <tr> <td>FSSV</td> <td>42.1</td> <td>35.3</td> <td>48.9</td> <td>6.8</td> <td>0.16</td> </tr> <tr> <td>FF</td> <td>85.4</td> <td>69</td> <td>101.6</td> <td>16.3</td> <td>0.19</td> </tr> </tbody> </table>	Forest type	Uncertainty estimate					Mean	Lower (5 <sup>th</sup> percentile)	Upper bound (95 <sup>th</sup> percentile)	Half-width confidence interval at 90%	Relative Margin	FSD	49.9	41.5	58.4	8.4	0.17	FSSV	42.1	35.3	48.9	6.8	0.16	FF	85.4	69	101.6	16.3	0.19
Forest type	Uncertainty estimate																													
	Mean	Lower (5 <sup>th</sup> percentile)	Upper bound (95 <sup>th</sup> percentile)	Half-width confidence interval at 90%	Relative Margin																									
FSD	49.9	41.5	58.4	8.4	0.17																									
FSSV	42.1	35.3	48.9	6.8	0.16																									
FF	85.4	69	101.6	16.3	0.19																									
<b>Any comment:</b>																														

<b>Parameter:</b>	$AGB_{after,i}$
<b>Description:</b>	Aboveground biomass of non-forest type <i>i</i> after conversion
<b>Data unit:</b>	tons of dry matter per ha
<b>Source of data or description of the method for developing the data including the spatial level of the data (local, regional,</b>	<p>For cropland: The values and assumptions of 2006 IPCC GL, Volume 4, Chapter 5 are used because, unfortunately, there aren't country-specific data. The agricultural land in Mozambique is mostly under the annual-crop farming practices that drive conversion of forest land to agricultural lands. So, according to 2006 IPCC GL (Volume 4, Chapter 5, Section 5.28), for lands planted in annual crops, the default value of growth in crops planted after conversion is 5 tonnes of C per hectare, based on the original IPCC Guidelines recommendation of 10 tonnes of dry biomass per hectare (dry biomass has been converted to tonnes carbon in Table 5.9) (2006 IPCC, Volume 4, Chapter 5, Section 5.28).</p> <p>For grassland: The values and assumptions of 2006 IPCC GL, Volume 4, Chapter 6 are used because, unfortunately, there aren't country-specific data. As the climate in most of Mozambique is tropical dry to subtropical dry, the value of peak-above ground biomass for tropical dry of TABLE 6.4 is assumed.</p> <p>For other lands: No default values exist for these conversions.</p>

<b>national, international):</b>	Spatial level: International																													
<b>Value applied:</b>	<table border="1"> <tr> <td>Cropland (C)</td> <td>10.00</td> </tr> <tr> <td>Grassland (P)</td> <td>2.30</td> </tr> <tr> <td>Other lands (A O U)</td> <td>0.00</td> </tr> </table> <p>The values above are recorded in the ranges "B5:B9", "B11:B15" and "B17:B21" of the "BIOMASS" worksheet tab in the "<a href="#">ZILMP Emissions Calculations MR (2019)</a>" and "<a href="#">ZILMP Emissions Calculations MR (2020)</a>" workbooks. These values are then applied in the range "D9:D20" of the "EMISSION MONITORING PERIOD(EMP)" worksheet tab in the "<a href="#">ZILMP Emissions Calculations MR (2019)</a>" and "<a href="#">ZILMP Emissions Calculations MR (2020)</a>" workbooks for estimating emissions.</p>	Cropland (C)	10.00	Grassland (P)	2.30	Other lands (A O U)	0.00																							
Cropland (C)	10.00																													
Grassland (P)	2.30																													
Other lands (A O U)	0.00																													
<b>QA/QC procedures applied</b>	The adequacy in the use of these default values was confirmed with the experts in GHG Inventory in DINAB.																													
<b>Uncertainty associated with this parameter:</b>	<table border="1"> <thead> <tr> <th rowspan="2">Non-forest type</th> <th colspan="5">Uncertainty estimate</th> </tr> <tr> <th>Mean</th> <th>Lower (5<sup>th</sup> percentile )</th> <th>Upper (95<sup>th</sup> percentile)</th> <th>Half-width confidence interval at 90%</th> <th>Relative Margin</th> </tr> </thead> <tbody> <tr> <td>Cropland (C)</td> <td>10</td> <td>3.9</td> <td>16.1</td> <td>6.1</td> <td>0.61</td> </tr> <tr> <td>Grassland (P)</td> <td>2.3</td> <td>0.9</td> <td>3.7</td> <td>1.4</td> <td>0.61</td> </tr> <tr> <td>Other lands (A O U)</td> <td>0</td> <td>0</td> <td>0</td> <td>0</td> <td>NA</td> </tr> </tbody> </table>	Non-forest type	Uncertainty estimate					Mean	Lower (5 <sup>th</sup> percentile )	Upper (95 <sup>th</sup> percentile)	Half-width confidence interval at 90%	Relative Margin	Cropland (C)	10	3.9	16.1	6.1	0.61	Grassland (P)	2.3	0.9	3.7	1.4	0.61	Other lands (A O U)	0	0	0	0	NA
Non-forest type	Uncertainty estimate																													
	Mean	Lower (5 <sup>th</sup> percentile )	Upper (95 <sup>th</sup> percentile)	Half-width confidence interval at 90%	Relative Margin																									
Cropland (C)	10	3.9	16.1	6.1	0.61																									
Grassland (P)	2.3	0.9	3.7	1.4	0.61																									
Other lands (A O U)	0	0	0	0	NA																									
<b>Any comment:</b>																														

<b>Parameter:</b>	BGB <sub>after,i</sub>		
<b>Description:</b>	Belowground biomass of non-forest type <i>i</i> after conversion		
<b>Data unit:</b>	tons of dry matter per ha		
<b>Source of data or description of the method for developing the data including the spatial level of the data (local, regional, national, international):</b>	<p>For cropland: The values and assumptions of 2006 IPCC GL, Volume 4, Chapter 5 are used because, unfortunately, there aren't country-specific data. Tier 2 may modify the assumption that carbon stocks immediately following conversion is zero. In this case, it is assumed that conversion leads to annual croplands and in the case the carbon stock in biomass after one year for annual crops provided in TABLE 5.9 is used.</p> <p>For grassland: The values and assumptions of 2006 IPCC GL, Volume 4, Chapter 6, TABLE 6.1 and TABLE 6.4 are used because, unfortunately, there aren't country-specific data. As the climate in most of Mozambique is tropical dry to subtropical dry, the value for semi-arid grassland in tropical dry climate zone is used, therefore a root-shoot ratio of 2.8 (TABLE 6.1) is applied to the value of peak above-ground biomass, 2.3 tonnes of dry biomass per hectare (TABLE 6.4), generating the expected values 6.4 tonnes of dry biomass per hectare.</p> <p>For other lands: No default values exist for these conversions.</p> <p>Spatial level: International</p>		
<b>Value applied:</b>	<table border="1"> <tr> <td>Cropland (C)</td> <td>0.00</td> </tr> </table>	Cropland (C)	0.00
Cropland (C)	0.00		

	<table border="1"> <tr> <td>Grassland (P)</td> <td>6.40</td> </tr> <tr> <td>Other lands (A O U)</td> <td>0.00</td> </tr> </table> <p>The values above are recorded in the ranges "B35:E39", "B41:B45" and "B47:B51" of the "BIOMASS" worksheet tab in the "<a href="#">ZILMP Emissions Calculations MR (2019)</a>" and "<a href="#">ZILMP Emissions Calculations MR (2020)</a>" workbooks. These values are then applied in the range "F9:F20" of the "EMISSION MONITORING PERIOD(EMP)" worksheet tab in the "<a href="#">ZILMP Emissions Calculations MR (2019)</a>" and "<a href="#">ZILMP Emissions Calculations MR (2020)</a>" workbooks for estimating emissions.</p>	Grassland (P)	6.40	Other lands (A O U)	0.00																									
Grassland (P)	6.40																													
Other lands (A O U)	0.00																													
<b>QA/QC procedures applied</b>	The adequacy in the use of these default values was confirmed with the experts in GHG Inventory in DINAB.																													
<b>Uncertainty associated with this parameter:</b>	<table border="1"> <thead> <tr> <th rowspan="2">Non-forest type</th> <th colspan="5">Uncertainty estimate</th> </tr> <tr> <th>Mean</th> <th>Lower (5<sup>th</sup> percentile)</th> <th>Upper bound (95<sup>th</sup> percentile)</th> <th>Half-width confidence interval at 90%</th> <th>Relative Margin</th> </tr> </thead> <tbody> <tr> <td>Cropland (C)</td> <td>0</td> <td>0</td> <td>0</td> <td>0</td> <td>NA</td> </tr> <tr> <td>Grassland (P)</td> <td>6.4</td> <td>-0.2</td> <td>12.8</td> <td>6.5</td> <td>1.02</td> </tr> <tr> <td>Other lands (A O U)</td> <td>0</td> <td>0</td> <td>0</td> <td>0</td> <td>NA</td> </tr> </tbody> </table>	Non-forest type	Uncertainty estimate					Mean	Lower (5 <sup>th</sup> percentile)	Upper bound (95 <sup>th</sup> percentile)	Half-width confidence interval at 90%	Relative Margin	Cropland (C)	0	0	0	0	NA	Grassland (P)	6.4	-0.2	12.8	6.5	1.02	Other lands (A O U)	0	0	0	0	NA
Non-forest type	Uncertainty estimate																													
	Mean	Lower (5 <sup>th</sup> percentile)	Upper bound (95 <sup>th</sup> percentile)	Half-width confidence interval at 90%	Relative Margin																									
Cropland (C)	0	0	0	0	NA																									
Grassland (P)	6.4	-0.2	12.8	6.5	1.02																									
Other lands (A O U)	0	0	0	0	NA																									
<b>Any comment:</b>																														

<b>Parameter:</b>	$A(j,i)_{RP}$
<b>Description:</b>	Area converted from forest type $j$ to non-forest type $i$ during the reference period.
<b>Data unit:</b>	hectare per year.
<b>Source of data and description of measurement /calculation methods and procedures applied:</b>	<p><i>i. Approach and source</i></p> <p>Activity data (AD) for deforestation were obtained from an annual historical time series analysis of land use, land-use change and forestry (LULUCF) carried out by five trained operators in approximately 98 effective working days (4.4 months), for the period of 2001 – 2016 across the country, using the Collect Earth Open tool.</p> <p>Activity data have been generated following IPCC Approach 3 for representing the activity data as described in the 2006 IPCC Guidelines for National Greenhouse Gas Inventories (Volume 4, Chapter 3, Section 3.13), i.e., using spatially-explicit observations of land-use categories and land-use conversions over time across the country, derived from sampling of geographically located points. The result was forest cover data for 2016 and forest cover change data for every year from 2001 to 2016.</p> <p>The period of AD analysis from 2005 to 2015 (11 years) considered for the ER Program area, could be adapted within the general period 2001 – 2016 with little effort, due to the operators collecting the date of the LULC change.</p> <p><i>ii. Sampling design</i></p>

A systematic 4 x 4 km grid consisting of a total of 48, 894 sampling points was established at a national level to generate the historical activity data for the entire area of the country using high and medium resolution imagery, which is the same grid used to allocate the NFI clusters from the Stratified Random Sampling design. At jurisdictional level, this corresponds to 3,308 points being interpreted. Each sampling point was visually assessed and its information was collected and entered in a complete database on LULC changes at the national level.

### iii. **Response design**

#### Spatial sampling unit

The spatial sampling unit from each point was defined as a point with a spatial support consisting of a 100m x 100m plot (1 ha), where an internal grid of 5 x 5 points (20m x 20m grid) is overlapped. Each point from the internal grid has a weight coverage of 4%.



Spatial sampling unit for the reference period

#### Source of reference data

The sampling approach for historical AD calculation based on the regular National 4 x 4 km grid has been designed and conducted using the high and medium resolution images repository available through Google Earth and Earth Engine as a visual assessment exercise. These imageries with digital forms designed to collect the LULCC information on the points of the grid are automatically accessible through the Collect Earth tool ([www.openforis.org](http://www.openforis.org)) along with scripts accessible through Earth Engine code that facilitate vegetation type's interpretation (e.g. MODIS or Landsat NDVI time series). Each point of the grid is photo-interpreted thanks to Collect Earth tool and the year and type of changes are also collected.

The use of various scripts programmed on Earth Engine Code facilitates the interpretation of the vegetation type and the determination of LULC changes. Specifically, the MOD13Q1 (NDVI 16-day Global Modis 250 m) graphic from 2001-2016, most recent Sentinel-2 image, most recent Landsat-8 pan sharpened image, Landsat-7 pan sharpened image (2000, 2004, 2008, 2012), etc.

The completeness of the series is guaranteed using RS products from medium resolution imagery repositories from 2001 (e.g. Annual TOA Reflectance Composite, Annual NDVI Composite, Annual EVI Composite, Annual Greenest-Pixel TOA Reflectance Composite, etc. from Landsat 5 TM) and the most recent Sentinel-2 image from 2016. In this way, a temporal analysis of LULC changes has been completed for each sampling point of the national 4 x 4 km grid (48,894 records).

The screenshot displays the Collect Earth Tool interface for LULCCF detection. It features a central satellite image with a yellow bounding box and a central ID '63886'. Surrounding the image are four panels:

- Top-left panel:** 'Elementos' section with a table of land cover elements and their coverage percentages.
 

Elemento	Cobertura
Árvores	40-49%
Arbustos	50-59%
Matagais	Não aplicável
Gramíneas	Não aplicável
Solo Exposto	Não aplicável
Cultivos	Não aplicável
Rio	Não aplicável
Lago	Não aplicável
Infraestrutura	Não aplicável
- Top-right panel:** 'Lulc Change' section with buttons for various transitions (C<math>C</math>, F<math>F</math>, P<math>P</math>, A<math>A</math>, U<math>U</math>, O<math>O</math>, T<math>C</math>, T<math>F</math>, T<math>P</math>, T<math>A</math>, T<math>A</math>, T<math>O</math>) and a 'Degradação' section with 'Sim' and 'Não' buttons. Below is a 'Mudança estimada na CD' dropdown set to '20-29%'.
- Bottom-left panel:** 'Uso da terra IPCC' section with buttons for 'Cultivos', 'Florestas', 'Pradarias', 'Áreas alagadas', 'Áreas urbanas', and 'Outras Terras'. It also includes 'Confiança IPCC' (Sim/Não), 'Classe nacional' (Floresta (Semi-) decídua fechada), 'Confiança classe nacional' (Sim/Não), 'Subclasse nacional' (Miombo denso), and 'Confiança subclasse nacional' (Sim/Não).
- Bottom-right panel:** 'Imagem de satélite (fornecedor)' section with 'Digital Globe' as the provider, 'Data da imagem atual' as '12/14/2016', and a 'Comentário' field.

Below the screenshot, the text reads: *LULCCF detection using Collect Earth Tool (www.openforis.org). Digital forms designed with Collect Tool.*

**Reference labelling protocol**

The activity data was generated considering the national land use and land cover classification system, which reflects the six broad IPCC Land Use categories. A set of hierarchical rules were established and used to determine the LULCCF category based on a certain percentage and taking into account the national forest definition as well. A single land use class is easier to classify, but it becomes challenging when there is a combination of two or more land use classes within the area of interest. Thus, this is where the hierarchical rules are important to determine the land use. Any sampling unit that has 30% of tree canopy cover is considered a forest, according to the national forest definition, even if it has more than 20% of settlements, crops or other land use, the forest has priority. In the case the sampling unit was classified as forest land and different forest types were present in the sampling unit, a majority rule was used in this case, i.e. the largest forest class is the winner.

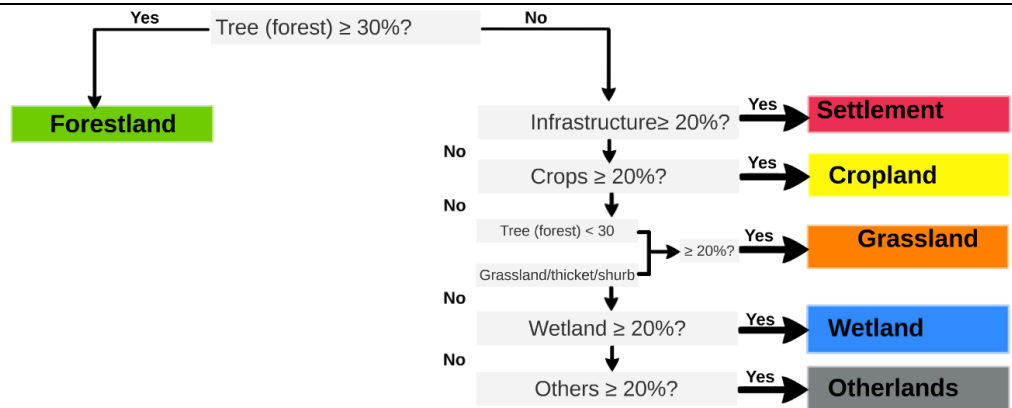

Decision tree for the attribution of the LULCCF category based on the percentage cover of the elements present in the sampling unit of 1 ha.

#### iv. Analysis

The estimation of the areas corresponding to a certain category changes from a forest type to a non-forest type in the framework of this systematic sampling approach was based on assessments of area proportions. According to 2006 IPCC Guidelines for National Greenhouse Gas Inventories (Volume 4, Chapter 3, Section 3.33), the proportion of each land-use or land-use change category is calculated by dividing the number of points located in the specific category by the total number of points, and area estimates for each land-use or land-use change category are obtained by multiplying the proportion of each category by the total area of interest, in this case, the ER Program accounting area.

$$A_i = p_i \times A \quad \text{Equation 7}$$

Where:

- $A_i$  Area estimate on forest type  $j$  converted to non-forest type  $i$ ; hectare
- $p_i$  Proportion of points on forest type  $j$  converted to non-forest type  $i$ ; dimensionless
- $A$  Total area of interest; hectare

$$p_i = \frac{n_i}{N} \quad \text{Equation 8}$$

Where:

- $n_i$  Number of points on forest type  $j$  converted to non-forest type  $i$ ; number
- $N$  Total number of points; number

Uncertainties in activity data were derived using non-parametric bootstrapping, where reference data points were re-sampled with replacement 100,000 times. For each permutation of reference data points, the bias-corrected area estimates were produced following the methods described in Olofsson *et al.* (2014). Uncertainty was estimated from the resulting distribution of area estimates. Although more complex to implement, bootstrapping has the advantages of not requiring any assumption about the shape of the probability distribution function of each land cover transition class, and avoids the generation of negative areas in rare classes where a probability distribution function crosses zero. The method was implemented in R, and the scripts used are available in the "[Mozambique ERPA 2020](#)" shared folder.

The impact of using non-parametric bootstrapping to estimate uncertainties vs other methods was tested with a comparison of deforested areas derived from bootstrapping



against sampling from a normal distribution with standard error calculated with the methods described in Olofsson *et al.* (2014) (Figure 7). For the latter case two uncertainties were derived: one retaining any negative area estimates for rare transition classes, and another setting these to zero. The result indicates that there is very little difference between any of the methods in either reference or monitoring periods, with the result that any chosen approach would produce equivalent emissions estimates.

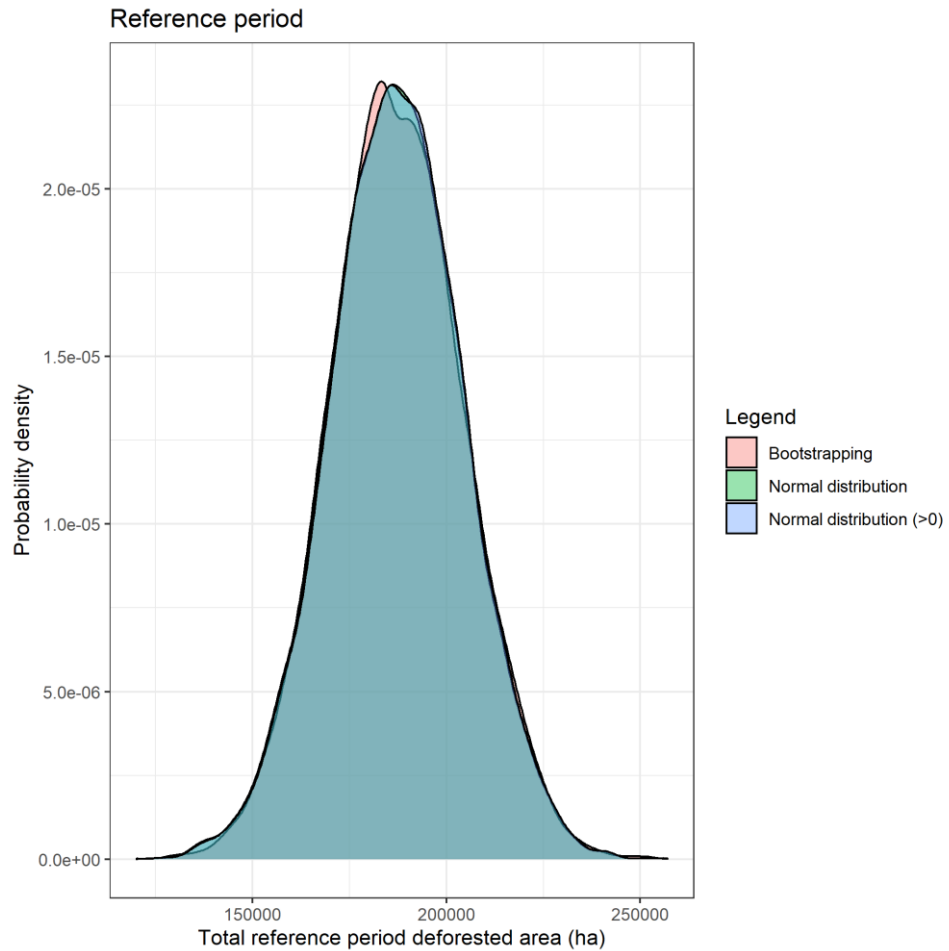

Figure 7: Total activity data area estimates for reference period using normal distributions for each transition class (red), normal distributions with a minimum area of 0 ha (green), and non-parametric bootstrapping (blue). All three methods result in equivalent uncertainty estimates.

**Value applied**

Semi-deciduous forest to cropland	11,785.07
Semi-deciduous forest to grassland	1,745.94
Semi-deciduous forest to other lands	145.49
Evergreen forest to cropland	3,200.88
Evergreen forest to grassland	145.49
Evergreen forest to other lands	0.0
Mangrove forest to cropland	0.0
Mangrove forest to grassland	0.0
Mangrove forest to other lands	0.0

<b>QA/QC procedures applied:</b>	<p>Quality Control consisted in having a team of 5 technicians with experience in forests and remote sensing, all trained together by an MRV specialist. The team worked in the same office, and discussed any classification issues with each other.</p> <p>Quality Assurance was conducted using the SAIKU extension of Collect Earth. This tool allows the detection of whether:</p> <ul style="list-style-type: none"> <li>i) Data point was not filled</li> <li>ii) The class assigned followed the classification hierarchy, based on the % of individual element cover</li> <li>iii) Year of the Old image/Change image was less than the current image</li> <li>iv) Change classes are consistent with previous and current classes</li> <li>v) Open and closed forest was correctly classified, based on the 30% (open) and 65% (closed) cover threshold</li> </ul> <p>In the case of any error being detected, the ID of the data point was registered and the user performed the necessary corrections.</p>																																														
<b>Uncertainty associated with this parameter:</b>	<table border="1"> <thead> <tr> <th rowspan="2">Category change</th> <th colspan="5">Uncertainty estimate (from non-parametric bootstrapping)</th> </tr> <tr> <th>Median</th> <th>Lower bound (5<sup>th</sup> percentile)</th> <th>Upper bound (95<sup>th</sup> percentile)</th> <th>Half-width confidence interval at 90%</th> <th>Relative Margin</th> </tr> </thead> <tbody> <tr> <td>FSD&gt;(A O U)</td> <td>291</td> <td>0</td> <td>873</td> <td>436.5</td> <td>1.5</td> </tr> <tr> <td>FSD&gt;C</td> <td>23570.1</td> <td>19496.3</td> <td>27935</td> <td>4219.4</td> <td>0.18</td> </tr> <tr> <td>FSD&gt;P</td> <td>3491.9</td> <td>2036.9</td> <td>5237.8</td> <td>1600.4</td> <td>0.46</td> </tr> <tr> <td>FSSV&gt;C</td> <td>6401.8</td> <td>4364.8</td> <td>8729.7</td> <td>2182.5</td> <td>0.34</td> </tr> <tr> <td>FSSV&gt;P</td> <td>291</td> <td>0</td> <td>873</td> <td>436.5</td> <td>1.5</td> </tr> </tbody> </table>						Category change	Uncertainty estimate (from non-parametric bootstrapping)					Median	Lower bound (5 <sup>th</sup> percentile)	Upper bound (95 <sup>th</sup> percentile)	Half-width confidence interval at 90%	Relative Margin	FSD>(A O U)	291	0	873	436.5	1.5	FSD>C	23570.1	19496.3	27935	4219.4	0.18	FSD>P	3491.9	2036.9	5237.8	1600.4	0.46	FSSV>C	6401.8	4364.8	8729.7	2182.5	0.34	FSSV>P	291	0	873	436.5	1.5
Category change	Uncertainty estimate (from non-parametric bootstrapping)																																														
	Median	Lower bound (5 <sup>th</sup> percentile)	Upper bound (95 <sup>th</sup> percentile)	Half-width confidence interval at 90%	Relative Margin																																										
FSD>(A O U)	291	0	873	436.5	1.5																																										
FSD>C	23570.1	19496.3	27935	4219.4	0.18																																										
FSD>P	3491.9	2036.9	5237.8	1600.4	0.46																																										
FSSV>C	6401.8	4364.8	8729.7	2182.5	0.34																																										
FSSV>P	291	0	873	436.5	1.5																																										
<b>Any comment:</b>																																															

### 3.2 Monitored Data and Parameters

<b>Parameter:</b>	$A(j,i)_{MP}$																																											
<b>Description:</b>	Area converted from forest type $j$ to non-forest type $i$ during the Monitoring Period.																																											
<b>Data unit:</b>	hectare per year.																																											
<b>Value monitored during this Monitoring / Reporting Period:</b>	<table border="1"> <thead> <tr> <th>Type of change</th> <th>2019</th> <th>2020</th> <th>Total</th> </tr> </thead> <tbody> <tr> <td>Semi-deciduous forest to cropland</td> <td>7160.88</td> <td>20677.07</td> <td>27837.95</td> </tr> <tr> <td>Semi-deciduous forest to grassland</td> <td>83.33</td> <td>205.33</td> <td>288.66</td> </tr> <tr> <td>Semi-deciduous forest to other lands</td> <td>0</td> <td>0</td> <td>0</td> </tr> <tr> <td>Evergreen forest to cropland</td> <td>617.43</td> <td>1721.12</td> <td>2338.55</td> </tr> <tr> <td>Evergreen forest to grassland</td> <td>0</td> <td>205.33</td> <td>205.33</td> </tr> <tr> <td>Evergreen forest to other lands</td> <td>0</td> <td>0</td> <td>0</td> </tr> <tr> <td>Mangrove forest to cropland</td> <td>0</td> <td>0</td> <td>0</td> </tr> <tr> <td>Mangrove forest to grassland</td> <td>0</td> <td>0</td> <td>0</td> </tr> <tr> <td>Mangrove forest to other lands</td> <td>0</td> <td>0</td> <td>0</td> </tr> </tbody> </table>				Type of change	2019	2020	Total	Semi-deciduous forest to cropland	7160.88	20677.07	27837.95	Semi-deciduous forest to grassland	83.33	205.33	288.66	Semi-deciduous forest to other lands	0	0	0	Evergreen forest to cropland	617.43	1721.12	2338.55	Evergreen forest to grassland	0	205.33	205.33	Evergreen forest to other lands	0	0	0	Mangrove forest to cropland	0	0	0	Mangrove forest to grassland	0	0	0	Mangrove forest to other lands	0	0	0
Type of change	2019	2020	Total																																									
Semi-deciduous forest to cropland	7160.88	20677.07	27837.95																																									
Semi-deciduous forest to grassland	83.33	205.33	288.66																																									
Semi-deciduous forest to other lands	0	0	0																																									
Evergreen forest to cropland	617.43	1721.12	2338.55																																									
Evergreen forest to grassland	0	205.33	205.33																																									
Evergreen forest to other lands	0	0	0																																									
Mangrove forest to cropland	0	0	0																																									
Mangrove forest to grassland	0	0	0																																									
Mangrove forest to other lands	0	0	0																																									
<b>Source of data and</b>	<i>i. Source</i>																																											

<p><b>description of measurement /calculation methods and procedures applied:</b></p>	<p>Activity data used for the monitoring period are obtained from a combination of an annual wall-to-wall deforestation map with sampling to generate deforested area estimates through a stratified estimator.</p> <p><b>ii. Variable of interest</b></p> <p>The variable of interest are all the transitions specified above. It is important to note that the variables of interest are not aligned to the strata as this is not required. Strata is linked to the likelihood of presence of deforestation events, whereas the variable of interest is linked to the possible transitions of deforestation per forest type and post-deforestation type.</p> <p><b>ii. Annual deforestation map</b></p> <p>The workflow used to produce annual deforestation map (2019 and 2020 separately) for the ZILMP program area follows the steps below:</p> <ol style="list-style-type: none"> <li>1. Produce two Sentinel-2 satellite imagery composites for the monitoring area, containing all images of wet season (i.e. January - May). For 2019 deforestation map, the first composite comprises the period between January 2019 to May 2019 denoted as the reference period and the second composite comprises the period from January 2020 to May 2020, referred as actual period for 2019. For 2020 deforestation map, the first composite (reference period) comprises the period between January 2020 to May 2020 and November 2020 the second composite (actual period) comprises the period from January 2021 to May 2021. The reason behind the selection of January - May as a reference and actual period of monitoring resides on the fact that it is the wet season, where the NDVI stability is very high in relation to the dry season, which starts in June to October, when most trees lose their foliage and makes it difficult the analysis of deforestation.</li> <li>2. Generate image features from reference period and actual period from the composites generated in previous step, to identify changes in forest cover. The image features have different vegetation indexes, namely, NDVI, EVI, SAVI, NBR, NDWI with respective sub-products such as NDVI 90th percentile, Normalized NDVI, and variation on NDVI.</li> <li>3. Generate training data on classes of deforestation, stable forest and stable non-forest by visual interpretation of composites from the reference and actual periods, and NDVI change detection image. The NDVI change detection image is a result of the difference of NDVI from the composites of reference and actual periods. The calculated NDVI change detection image helps the interpreter to locate where the changes of forest cover are occurring.</li> <li>4. Produce a categorical deforestation map from training data and image features through a process of classification using Random Forest classifier. The Categorical deforestation map includes non-forest stable and stable forest classes. Because errors of omission of deforestation have a very large impact on the final estimates, it is important to reduce these errors as much as possible.</li> <li>5. To improve the efficacy of the sampling the deforestation class on the map is reclassified as: <ol style="list-style-type: none"> <li>a) High probability deforestation (cluster of more than 10 pixels of deforestation, corresponding to at least 40% of one hectare);</li> <li>b) Low probability of deforestation (cluster of less than 10 pixels and greater than 6 pixels, corresponding at least 24% to 40% of one hectare) and;</li> </ol> </li> </ol>
---	--

- c) Non-forest (cluster of less than 6 pixels, corresponding to less than 20% of a hectare).
6. To reduce the risk of omission errors, a Buffer of 40 meters is added around the high probability of deforestation class. The result is a deforestation map with five classes: *High probability of deforestation; buffer; low probability of deforestation; stable forest and stable non-forest.*

**v. Sampling design**

Sampling method

Monitoring of activity data for annual reporting is conducted using a stratified estimator, where deforestation map (which includes classes of forest and non-forest) is used for stratification and reference-sampling units are used for estimate activity data and associated confidence intervals.

Sample size determination

The sample size  $n$  was determined from the equation:

$$n = \frac{(\sum W_i S_i)^2}{[S(\hat{O})]^2 + \left(\frac{1}{N}\right) \sum W_i S_i} \approx \left(\frac{\sum W_i S_i}{S(\hat{O})}\right)^2 \quad \text{Equation 9}$$

Where:

- $N$  Number of units in the ROI
- $S(\hat{O})$  Standard error of the estimated overall accuracy that we would like to achieve
- $W_i$  Mapped proportion of area of class  $i$ ; and
- $S_i$  Standard deviation of stratum  $i$ .

The standard deviation of stratum  $i$  is given by the formula:

$$S_i = \sqrt{U_i(1 - U_i)} \quad \text{Equation 10}$$

Where:

- $U_i$  Proportion of area of deforestation in stratum  $i$ .

In order to obtain approximate values of proportion of deforestation in each stratum ( $U_i$ ), a pilot sampling is conducted. This pilot consists of 100 sample units per stratum.

Sample units per stratum

After the pilot sampling, sample units may need to be added to each stratum, in order to achieve 20% relative margin error at 95% confidence level. It was decided to use the Optimum (Neyman) allocation for each change stratum, where the stratum standard deviation  $S_i = \sqrt{U_i \cdot (1 - U_i)}$  increases the number of plots (ensuring larger numbers of plots in rare classes or strata) and sampling unit costs are constant:

$$n_i = n \frac{w_i \cdot S_i}{\sum_{i=1}^I w_i \cdot S_i} \quad \text{Equation 11}$$

For each stable stratum, the proportional allocation is applied if deforestation omission errors are completely absent from these strata. In stratified sampling the sample size for proportional allocation is given by:

$$n_i = n \cdot w_i \quad \text{Equation 12}$$

The number of reference points is presented in Table 4.

Table 4: Number of reference sampling units per map stratum for 2019 and 2020 deforestation maps.

Stratum	Number of sample units (2019)	Number of sample units (2020)
High probability of deforestation	100	100
40 m Buffer	100	100
Low probability of deforestation	100	100
Forest	300	300
Non-forest	300	300
<b>Total</b>	<b>900</b>	<b>900</b>

**v. Response design**

Sampling unit and spatial support

The sampling unit is a 20 m pixel of the stratification map that was produced. The spatial support used is a 100m x 100m plot (1ha). Each Spatial sampling unit contains an internal grid of 5 x 5 points (20m x 20m grid) to aid in the labelling attribution (Figure 8).



Figure 8: Spatial sampling unit.

Source of reference data

Each sampling unit was evaluated using Collect Earth (<http://www.openforis.org/>). This tool enables access to high-resolution images in Google Earth, Bing Maps and Planet Labs, as well as a medium resolution image repository available through Google Earth Engine Explorer and Code Editor (Landsat and Sentinel-2). The tool enables to display digital forms designed to collect the Land-Use Land Cover Change and Forestry (LULCCF) information on the sampling

points (Figure 9). The Earth Engine Code Editor facilitates the interpretation of the vegetation type and the determination of LULC changes, by displaying the historical MOD13Q1 (NDVI 16-day Global Modis 250 m) graphic as well as monthly mosaics of Sentinel-2 images. The main source of data to identify changes in land cover, is Sentinel-2 15 days' reflectance composite. However, Planet data is also used in cases of doubt or excessive cloud cover with Sentinel-2.

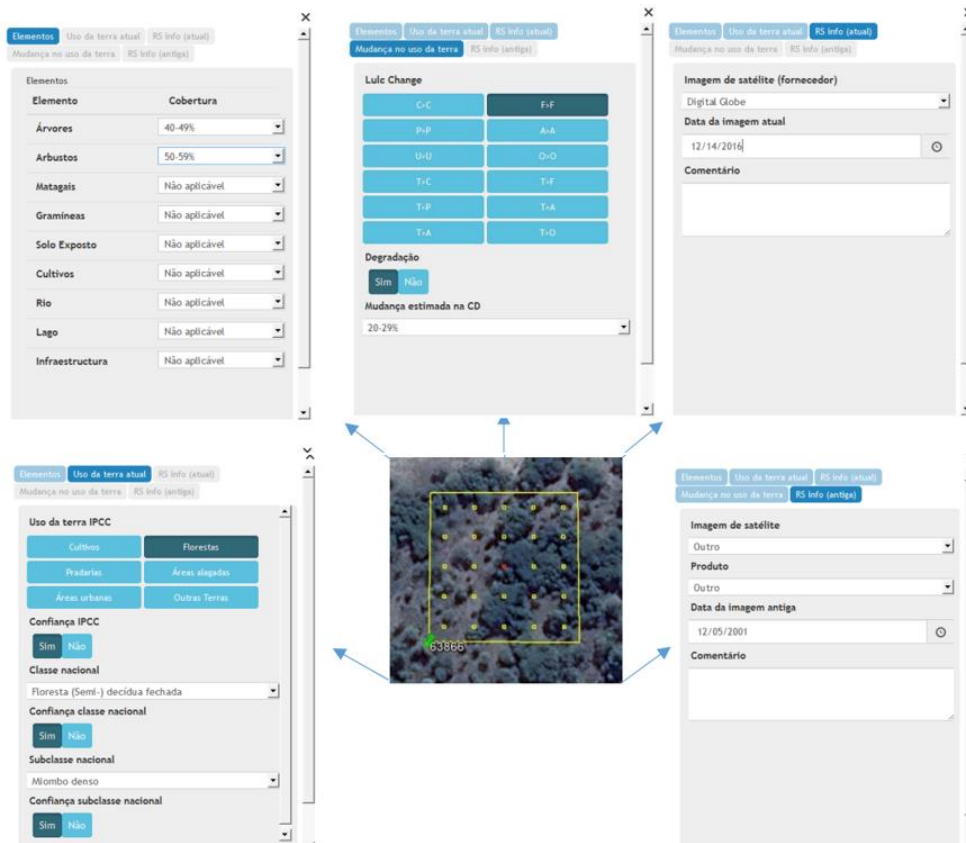

Figure 9: LULCCF detection using Collect Earth Tool ([www.openforis.org](http://www.openforis.org)). Digital forms designed with Collect Tool.

### Reference labelling protocol

The activity data was generated considering the national land use and land cover classification system, which reflects the six broad IPCC Land Use categories.

A set of hierarchical rules were established and used to determine the LULCCF category based on a certain percentage and taking into account the national forest definition as well (Figure 10). A single land use class is easier to classify, but it becomes challenging when there is a combination of two or more land use classes within the area of interest. Thus, this is where the hierarchical rules are important to determine the land use. Any sampling unit that has 30% of tree canopy cover is considered a forest, according to the national forest definition, even if it has more than 20% of settlements, crops or other land use, the forest is priority.

In the case the sampling unit was classified as forest land and different forest types were present in the sampling unit, a majority rule was used in this case, i.e. the largest forest class is chosen (please click [here](#) for more details).

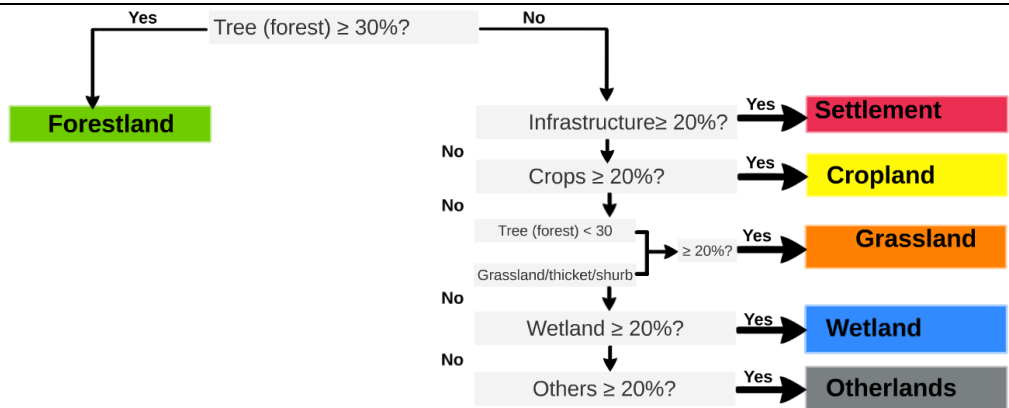

Figure 10: Decision tree for the attribution of the LULCCF category based on the percentage cover of the elements present in the sampling unit of 1 ha.

**vi. Analysis**

Applying the methodology described in Olofsson *et al.* (2014)<sup>9</sup> and the GFOI MGD (<https://www.reddcompass.org/download-the-mgd>), the estimations of the areas corresponding to land-use and land-cover change categories, more specifically the activity data for deforestation, in the framework of this stratified random sampling approach (based on the visual assessment of the 1 ha plots) was based on assessments of area proportions. A sample error matrix is constructed where the map classes ( $h=1, 2, \dots, q$ ) are represented by rows and the reference data ( $k=1, 2, \dots, q$ ) by columns as shown in Table 5. The size of strata and original proportion matrix can be found in [2019](#) and [2020](#) spreadsheets.

Table 5: Error matrix of area proportions.

Map data	Reference data					Total	User's accuracy ( $\hat{U}_i$ )
	Deforestation			Stable forest	Stable non-forest		
	High probability of deforestation	40 m Buffer	Low probability of deforestation				
High probability of deforestation	$\hat{p}_{11}$	$\hat{p}_{12}$	$\hat{p}_{13}$	$\hat{p}_{14}$	$\hat{p}_{15}$	$\hat{p}_1$	$\hat{p}_{11}/\hat{p}_1$
40 m Buffer	$\hat{p}_{21}$	$\hat{p}_{22}$	$\hat{p}_{23}$	$\hat{p}_{24}$	$\hat{p}_{25}$	$\hat{p}_2$	$\hat{p}_{22}/\hat{p}_2$
Low probability of deforestation	$\hat{p}_{31}$	$\hat{p}_{32}$	$\hat{p}_{33}$	$\hat{p}_{34}$	$\hat{p}_{35}$	$\hat{p}_3$	$\hat{p}_{33}/\hat{p}_3$
Stable forest	$\hat{p}_{41}$	$\hat{p}_{42}$	$\hat{p}_{43}$	$\hat{p}_{44}$	$\hat{p}_{45}$	$\hat{p}_4$	$\hat{p}_{44}/\hat{p}_4$
Stable non-forest	$\hat{p}_{51}$	$\hat{p}_{52}$	$\hat{p}_{53}$	$\hat{p}_{54}$	$\hat{p}_{55}$	$\hat{p}_5$	$\hat{p}_{55}/\hat{p}_5$
Total	$\hat{p}_{.1}$	$\hat{p}_{.2}$	$\hat{p}_{.3}$	$\hat{p}_{.4}$	$\hat{p}_{.5}$	1	
Producer's accuracy ( $P_i$ )	$\hat{p}_{11}/\hat{p}_{.1}$	$\hat{p}_{22}/\hat{p}_{.2}$	$\hat{p}_{33}/\hat{p}_{.3}$	$\hat{p}_{44}/\hat{p}_{.4}$	$\hat{p}_{55}/\hat{p}_{.5}$		Overall accuracy ( $\hat{O}$ ) $= \hat{p}_{11} + \hat{p}_{22} + \hat{p}_{33} + \hat{p}_{44} + \hat{p}_{55}$

The mean estimator for the area of each class can be directly obtained from the error matrix. Unbiased stratified estimators are provided using reference class area proportions ( $\hat{p}_{.k}$ ):

$$\hat{p}_{.k} = \sum_{h=1}^H w_h \cdot \frac{n_{hk}}{n_h} = \sum_{h=1}^H \hat{p}_{hk} \quad \text{Equation 13}$$

Where:

$\hat{p}_{.k}$  Area proportions of reference data class  $k$ . These proportions of reference data for deforestation classes as a whole are collapsed in three possible types of conversions/transitions from forest type  $j$  to non-forest type  $i$ , namely:

- Broadleaved (Semi-) deciduous to Non-forest type  $i$ ;
- Broadleaved (Semi-) evergreen to Non-forest type  $i$ ; and
- Mangrove to Non-forest type  $i$ .

Five types of non-forest land are considered:

- Cropland (C);
- Grassland (P);
- Wetland (A);
- Settlement (U); and
- Other lands (O).

$w_h$  Proportion of area mapped as class  $h$ ;

$n_{hk}$  Sample count at cell  $(h,k)$ ;

$n_h$  Sum of sample counts across row  $h$ ; and

$\hat{p}_{hk}$  Proportion of area in cell  $(h,k)$ .

Once the estimated reference class area proportions ( $\hat{p}_{.k}$ ) are obtained, the mean total area per class is calculated by multiplying them with the total reporting area  $a$ :

$$\hat{A}_j = \hat{p}_{.k} \cdot a \quad \text{Equation 14}$$

Uncertainty in activity data were derived using non-parametric bootstrapping, where reference data points were re-sampled with replacement 100,000 times. For each permutation of reference data points, the bias-corrected area estimates were produced following the methods described in Olofsson *et al.* (2014). Uncertainty was estimated from the resulting distribution of area estimates. Although more complex to implement, bootstrapping has the advantages of not requiring any assumption about the shape of the probability distribution function of each land cover transition class, and avoids the generation of negative areas in rare classes where a probability distribution function crosses zero. The method was implemented in R, and the scripts used are available in the “Mozambique Monitoring report 2020” shared folder.

The impact of using non-parametric bootstrapping to estimate uncertainties vs other methods was tested with a comparison of deforested areas derived from bootstrapping against sampling from a normal distribution with standard error calculated with the methods described in Olofsson *et al.* (2014). For the latter case, two uncertainties were derived: one retaining any negative area estimates for rare transition classes, and another setting these to zero. The result indicates that there is very little difference between any of the methods in either reference or monitoring periods, with the result that any chosen approach would produce equivalent emissions estimates.

<sup>9</sup> Olofsson, P., Foody, G.M., Herold, M., Stehman, S.V., Woodcock, C.E., & Wulder, M.A. 2014. Good practices for estimating area and assessing accuracy of land change. *Remote Sensing of Environment*. 148:42-57.



	<p style="text-align: center;">Monitoring period</p> <p style="text-align: center;">Total monitoring period deforested area (ha)</p> <p style="text-align: right;">Legend</p> <ul style="list-style-type: none"> <li><span style="color: red;">█</span> Bootstrapping</li> <li><span style="color: green;">█</span> Normal distribution</li> <li><span style="color: blue;">█</span> Normal distribution (&gt;0)</li> </ul> <p><i>Figure 11: Total activity data area estimates for the monitoring period using normal distributions for each transition class (red), normal distributions with a minimum area of 0 ha (green), and non-parametric bootstrapping (blue). All three methods result in equivalent uncertainty estimates.</i></p>
<p><b>QA/QC procedures applied:</b></p>	<p>The QA/QC procedures consisted on the following:</p> <ul style="list-style-type: none"> <li>● SOPs were developed as described in <i>Section 2.1 - Satellite and land monitoring system</i> and training; and</li> <li>● Interpretation is done by highly qualified professionals which are specialized in land cover interpretation with satellite imagery. They were trained and a robust control system is in place to ensure that they are correctly calibrated throughout the data collection process.</li> <li>● All reference data interpreted as deforestation, and an additional 20% of the remaining reference data were evaluated. The quality control is carried out by two independent supervisors, who after the independent evaluation compare the two evaluations and consensually compile a single comment for each sample. The parameters to be taken into account in the evaluation for identifying errors are: a) the percentage of coverage for each element within the plot; b) the current land cover/land use class (levels 1 and 2); c) the land cover/land use change class; d) the former land cover/land use class (levels 1 and 2); and e) the date of occurrence of land cover/land use change, or evidence date of remaining land cover/land use. If there are gross errors related to the parameters b), c) and d) in at least 20% of samples from the 20% mentioned initially, the respective interpreter should review all samples from the batch, otherwise the interpreter reviews only the samples evaluated by the supervisors, that present gross errors. On the other hand, in</li> </ul>

	<p>relation to all samples interpreted as deforestation, the interpreter reviews only the samples that present gross errors according to the evaluation from the supervisors. The process is cyclical until the interpreter achieves values less than 20% of gross errors in the batch.</p> <ul style="list-style-type: none"> <li>The uncertainty analysis approach was reviewed by Philip Mundhenk, a professor of the University of Hamburg specialized in Monte Carlo simulations.</li> </ul>																																			
<b>Uncertainty for this parameter:</b>	<table border="1"> <thead> <tr> <th rowspan="2">Category change</th> <th colspan="5">Uncertainty estimate (from non-parametric bootstrapping)</th> </tr> <tr> <th>Median</th> <th>Lower bound (5<sup>th</sup> percentile)</th> <th>Upper bound (95<sup>th</sup> percentile)</th> <th>Half-width confidence interval at 90%</th> <th>Relative Margin</th> </tr> </thead> <tbody> <tr> <td>FSD&gt;C</td> <td>27812.4</td> <td>25022.6</td> <td>30704.3</td> <td>2840.85</td> <td>0.1</td> </tr> <tr> <td>FSD&gt;P</td> <td>268.8</td> <td>0</td> <td>715.9</td> <td>357.95</td> <td>1.33</td> </tr> <tr> <td>FSSV&gt;C</td> <td>2332.7</td> <td>1342.4</td> <td>3409</td> <td>1033.3</td> <td>0.44</td> </tr> <tr> <td>FSSV&gt;P</td> <td>199.3</td> <td>0</td> <td>603.9</td> <td>301.95</td> <td>1.52</td> </tr> </tbody> </table>	Category change	Uncertainty estimate (from non-parametric bootstrapping)					Median	Lower bound (5 <sup>th</sup> percentile)	Upper bound (95 <sup>th</sup> percentile)	Half-width confidence interval at 90%	Relative Margin	FSD>C	27812.4	25022.6	30704.3	2840.85	0.1	FSD>P	268.8	0	715.9	357.95	1.33	FSSV>C	2332.7	1342.4	3409	1033.3	0.44	FSSV>P	199.3	0	603.9	301.95	1.52
Category change	Uncertainty estimate (from non-parametric bootstrapping)																																			
	Median	Lower bound (5 <sup>th</sup> percentile)	Upper bound (95 <sup>th</sup> percentile)	Half-width confidence interval at 90%	Relative Margin																															
FSD>C	27812.4	25022.6	30704.3	2840.85	0.1																															
FSD>P	268.8	0	715.9	357.95	1.33																															
FSSV>C	2332.7	1342.4	3409	1033.3	0.44																															
FSSV>P	199.3	0	603.9	301.95	1.52																															
<b>Any comment:</b>	-																																			

## 4 QUANTIFICATION OF EMISSION REDUCTIONS

### 4.1 ER Program Reference level for the Monitoring / Reporting Period covered in this report

Year of Monitoring/Reporting period <i>t</i>	Average annual historical emissions from deforestation over the Reference Period (tCO <sub>2-e</sub> /yr)	If applicable, average annual historical emissions from forest degradation over the Reference Period (tCO <sub>2-e</sub> /yr)	If applicable, average annual historical removals by sinks over the Reference Period (tCO <sub>2-e</sub> /yr)	Adjustment, if applicable (tCO <sub>2-e</sub> /yr)	Reference level (tCO <sub>2-e</sub> /yr)
2019	5,253,267.99	-	-	-	5,253,267.99
2020	5,253,267.99	-	-	-	5,253,267.99
<b>Total</b>	<b>10,506,535.98</b>	-	-	-	<b>10,506,535.98</b>

### 4.2 Estimation of emissions by sources and removals by sinks included in the ER Program's scope

The following table shows the emissions results obtained per category changes from a forest type to a non-forest type during the Monitoring Period. The emissions are generated relating the data and parameters described in Section 3 and summarized in the Table 6, by applying Equation 6.

Table 6: Calculation of the emissions from the ER Program during the Monitoring Period (2019-2020).

Category changes	AGB <sub>before,j</sub> (tdm/ha)	BGB <sub>before,j</sub> (tdm/ha)	AGB <sub>after,i</sub> (tdm/ha)	BGB <sub>after,i</sub> (tdm/ha)	Year of Monitoring/Reporting Period			
					2019		2020	
					A <sub>(j,i)MP</sub> (ha)	Emissions (tCO <sub>2</sub> e)	A <sub>(j,i)MP</sub> (ha)	Emissions (tCO <sub>2</sub> e)
Semi-deciduous forest to cropland	144.69	49.95	10.00	0.00	7,160.88	2,278,507.60	20,677.07	6,579,197.27
Semi-deciduous forest to grassland	144.69	49.95	2.30	6.40	83.33	26,693.99	205.33	65,778.66
Semi-deciduous forest to other lands	144.69	49.95	0.00	0.00	0.00	0.00	0.00	0.00
Evergreen forest to cropland	123.13	42.06	10.00	0.00	617.43	165,125.26	1,721.12	460,296.45
Evergreen forest to grassland	123.13	42.06	2.30	6.40	0.00	0.00	205.33	55,358.62
Evergreen forest to other lands	123.13	42.06	0.00	0.00	0.00	0.00	0.00	0.00
Mangrove to cropland	269.01	85.43	10.00	0.00	0.00	0.00	0.00	0.00
Mangrove to grassland	269.01	85.43	2.30	6.40	0.00	0.00	0.00	0.00
Mangrove to other lands	269.01	85.43	0.00	0.00	0.00	0.00	0.00	0.00
<b>Total</b>						<b>2,470,326.85</b>		<b>7,160,631.00</b>

Year of Monitoring/Reporting Period	Emissions from deforestation (tCO <sub>2</sub> -e/yr)	If applicable, emissions from forest degradation (tCO <sub>2</sub> -e/yr)*	If applicable, removals by sinks (tCO <sub>2</sub> -e/yr)	Net emissions and removals (tCO <sub>2</sub> -e/yr)
2019	2,470,326.85	-	-	2,470,326.85
2020	7,160,631.00	-	-	7,160,631.00
<b>Total</b>	<b>9,630,957.85</b>	-	-	<b>9,630,957.85</b>

### 4.3 Calculation of emission reductions

Total Reference Level emissions during the Reporting Period (tCO <sub>2</sub> -e)	10,506,535.98
Net emissions and removals under the ER Program during the Reporting Period (tCO <sub>2</sub> -e)	9,630,957.85
Emission Reductions during the Reporting Period (tCO <sub>2</sub> -e)	875,578.13

## 5 UNCERTAINTY OF THE ESTIMATE OF EMISSION REDUCTIONS

### 5.1 Identification, assessment and addressing sources of uncertainty

Table 7: Sources of uncertainty to be considered under the FCPF MF.

Sources of uncertainty	Analysis of contribution to overall uncertainty	Contribution to overall uncertainty (High / Low)	Addressed through QA/QC?	Residual uncertainty estimated?
<b>Activity Data</b>				
Measurement	<p>This error represents the operator error during the interpretation of LULCC on sampled points and inconsistencies between operators. This error is reduced by extensive QA/QC procedures.</p> <p>Quality control was guaranteed by having a team of technicians with experience in forests and remote sensing, all trained using the same methodology. The team worked in the same office, and discussed any classification issues with each other. Moreover, specific SOPs were defined in order to ensure the consistency in the interpretations.</p> <p>Quality control was conducted using the SAIKU extension of Collect Earth. This tool allows the detection of whether:</p> <ul style="list-style-type: none"> <li>(i) Data point was not filled</li> <li>(ii) The class assigned followed the classification hierarchy, based on the % of individual element cover</li> <li>(iii) Year of the Old image/Change image was less than the current image</li> <li>(iv) Change classes are consistent with previous and current classes</li> <li>(v) Open and closed forest was correctly classified, based on the 30% (open) and 65% (closed) cover threshold</li> </ul> <p>In the case of any error being detected, the ID of the data point was registered and the user performed the necessary corrections.</p>	High (bias/random)	YES	NO

	All sampling units detected as deforestation and 20% of the remaining sampling units are subjected to quality assurance (QA). This QA is performed by 2 independent reviewers, who compare their evaluations of each sampling unit, to reach a decision on whether the chose sampling unit was correctly evaluated or not. The critical evaluated parameters, which determine whether a sample has to be reviewed by the user are: land cover class (level 1 and 2), land cover change class and previous land cover class (in case of change). If errors are detected in at least 20% of the reviewed sampling units from the 20% mentioned initially, then the operator has to reanalyze their lot. This process is cyclical, until less than 20% of the sampling units are found to have errors.			
Representativeness	This source of error is related to the representativeness of the estimate which is related to the sampling design. We produce annual deforestation maps as the basis for stratification, to ensure that our sample is representative of the area of interest. We applied a probabilistic-based sampling, where all areas have an inclusion probability larger than zero	Low	YES	NO
Sampling	Sampling error is the statistical variance of the estimate of area for the applicable forest transitions that are reported by the ER Program. This source of error is random. Mozambique has followed Good Practices regarding estimating the contribution of this error.  For the reference period we used systematic sampling, which does not have an unbiased estimator for the variance. The variance estimation formulae for simple random sampling were used as a conservative option.  For the monitoring period we used stratified sampling and the method described by Olofsson (2014).	High (bias/random)	YES	YES
Extrapolation	This source of uncertainty is not applicable to our approach. We generate estimates of deforestation per forest type, based on reference data.	N.A.	N.A.	NO
Approach 3	This source of uncertainty exists when there is no tracking of lands or IPCC Approach 3, which is the case for Mozambique. We do not consider that the time-span of the Reference Period + Monitoring Period is sufficient for a land to have been deforested, grown back to forest and then deforested again.  With the methodology used in the reference period, it was not possible to double count deforestation events, as we analyzed the entire period. On the other hand, this is a possibility in the monitoring period. Because we are only accounting for deforestation this is conservative with regards to our emissions reductions estimate.  Mozambique does not have a clear definition of the time-span required for a land to be considered to have been converted “back” to forest after a deforestation event.	H/L (bias)	YES	NO

Emission factor				
DBH measurement	<p>Strong QA/QC processes were implemented:</p> <ul style="list-style-type: none"> <li>SOPs were developed as described in <i>Section 2.1 - National Forest Inventory</i>.</li> <li>A training on the SOPs was conducted prior to the field work. This training lasted for 3 weeks, and consisted of training on the usage of all equipment and evaluating the specific skills of each participant, in order to determine the team and brigade leaders. On the start of the 2<sup>nd</sup> phase of the IFN (2017) an additional 1-week training was conducted, to refresh the participants and train any new members.</li> <li>The supervisor of each inventory team conducted a remeasurement of 4 trees per plot which means 16 trees per cluster. This served to ensure that the SOPs were adequately implemented.</li> <li>An independent measurement of 10% of the plots. Technicians of the National Directorate of Forests, who had participated in the Provincial Inventories of Gaza and Cabo Delgado, conducted this activity. Diameter below 10%.</li> <li>The World Bank conducted two regular supervision missions of the National Forest Inventories to confirm the adequate implementation of the SOPs and suggest areas for improvement.</li> </ul> <p>As a result of these QA/QC procedures the possible bias in the measurement of DBH and H have been addressed and the measurement random error is considered to be low. Hence, this source of error will not be propagated.</p>	H (bias) & L (random)	YES	NO
H measurement		H (bias) & L (random)	YES	NO
Plot delineation		H (bias) & L (random)	YES	NO
Wood density measurement	The allometric equations used by Mozambique do not include wood density, so this source of error will not be propagated.	N.A.	N.A.	NO
Other parameters (e.g. Carbon Fraction, root-to-shoot ratios)	<p>Carbon fraction parameter was taken from the 2006 IPCC Guidelines. Error, as provided from the IPCC Guidelines, has been propagated. Sensitivity analysis showed a very small effect of this parameter.</p> <p>Root-to-shoot ratios were used for one of the strata (Evergreen Forest), with the value taken from the 2006 IPCC Guidelines. Within this stratum, we only applied the root-to-shoot ratio to species which were not covered by specific equations, as described in Section 3.1 of this report.</p> <p>Since the previous MR (2018) Mozambique has integrated emission factor estimation within the automated processing chain. As a result, we have propagated Root-to-shoot ratios as per the guidelines.</p>	H (bias) & L (random)	YES	YES
Biomass allometric equation (Model error)	Allometric equations used ranged from national (specific species, and evergreen MoUntain forest), to regional (for mangrove), international (Semi-deciduous forest) and IPCC defaults (evergreen forests). However, effect on emission reductions is expected to be low, as emission factors remain	H (random/bias)	YES	YES

	<p>constant from reference to monitoring period. Additionally, the overall effect of emission factor uncertainty on total uncertainty is low (10.4%).</p> <p>The equations used for semi-deciduous forest and evergreen forest were not validated with data from Mozambique, which is a source of bias. Unfortunately, this was not feasible due to financial reasons. As QA/QC procedure, the selection of the equations was discussed with experts from the Eduardo Mondlane University and IIAM who confirmed that these are the most representative and best available equations, which will provide accurate estimates, as far as practice.</p> <p>According to the experts, although there might be an associated bias from using the equation, it is safer to use the equation of Mugasha et al. 2013 (more representative "ecosystems and species") than using the adjusted equations in Mozambique (less representative "ecosystems and species"). It is because the adjusted equations in Mozambique mostly recommended for specific areas (example of one of the best-adjusted Miombo equation "Guedes et al. 2018" recommended only to estimate biomass in low Miombo of Beira corridor). In addition, if they are applicable to extensive ecosystems, they present a high level of uncertainty (example is the equation of Miombo adjusted by Chaúque 2004, which has <math>R^2 = 0.78</math>), which is associated with low representation of species and diameter range of the trees used during equation adjustment.</p> <p>On the other hand, Mugasha et al 2013 used data from 60 species (about half of which occur in Zambézia) from 1 to 110 cm of dbh, coming from Miombo woodland (which according to Chidumayo &amp; Gumbo, 2010 "The Dry Forests and Woodlands of Africa", this forest type are similar in terms of floristic composition and structure to those of Mozambique). In addition, the last paragraph of conclusion of the authors' article where they show no reservations about the use of the equation in other regions of southeastern Africa.</p> <p>Currently the MRV unit has plans to establish MoU with research institutions to develop and/or adjust more accurate allometric equations for various ecosystems in the country, and thus update the emission factors.</p> <p>Since the previous MR (2018) Mozambique has included propagation of this source of error in MC simulations for all the strata and pools for which allometric equations are used. As a result the previous application of increased sampling uncertainty of AGB and BGB (of FSD and FSSV forest types) by 10% at 90% confidence level using the quadrature approach has been removed, with the exception of FSSV BGB, which does not have an allometric equation, but rather uses R:S ratio.</p>			
Sampling	Sampling error is the statistical variance of the estimate of aboveground biomass, dead wood or litter. This source of error is random and is considered to be high and it has been propagated.	H (random/bias)	YES	YES

	The estimation of mean and their respective uncertainties (standard error, sampling error, and confidence interval) for the variables biomass, carbon and carbon dioxide equivalent (above and below ground) for the two strata (semi-deciduous forest and semi-evergreen forest), were done using the forest inventory data analysis approach proposed by Bechtold & Patterson (2005), as suggested by the independent expert (Jim Alegria, ex-US Forestry Service) hired to evaluate the methodology for the inventory.			
Representativeness error	This source of error is related to the representativeness of the estimate which is related to the sampling design. For semi-deciduous and evergreen forest, data are from the Zambézia Forest Inventory. It includes data that was collected in Zambézia province during the NFI, in 2017 and 2018. Although the inventory covers the whole province of Zambézia, this is still representative of the forests located in the ZILMP as forests across the province are homogenous (floristic and structural composition). Moreover, the higher sample size of the inventory covering the whole province will enable more precise estimates for emission factors. This source of uncertainty is considered to be low.	<i>H/L (bias)</i>	YES	NO
<b>Integration</b>				
Model error	The combination of AD & EF does not necessarily need to result in additional errors. Usually, sources of both random and systematic error are the calculations themselves (e.g. mistakes made in spreadsheets). The spreadsheets used for activity data and emissions estimation are derived from multiple past implementations and have been refined over several years. The MRV team has implemented an automated script to calculate emissions and uncertainty. This should greatly reduce the possibility of mistakes in the calculations. The outputs of the activity data and emissions spreadsheets were checked against R implementation and they matched.  The worksheet for emission factor estimation was developed in consultation with, and checked by, an independent expert (Jim Alegria, ex-US Forestry Service).	<i>L (bias)</i>	YES	NO
Integration	This source of error is linked to the lack of comparability between the transition classes of the Activity Data and those of the Emission Factors. Considering the homogeneity of forests in Zambézia, the distinguishing feature of the two land strata (semi-deciduous and evergreen) are the phenological behavior. The <i>Collect Earth</i> software provides a time-series of NDVI over the plot, which is used to determine whether a forest is deciduous or evergreen. More detail of this can be seen in our step-by-step description of activity data collection ( <a href="https://www.fnds.gov.mz/mrv/index.php/documentos/guiões/46-protocolo-de-monitoria-e-estimativa-de-emissoes-por-desmatamento-vjun2021/file">https://www.fnds.gov.mz/mrv/index.php/documentos/guiões/46-protocolo-de-monitoria-e-estimativa-de-emissoes-por-desmatamento-vjun2021/file</a> ).	<i>L (bias)</i>	YES	NO



## 5.2 Uncertainty of the estimate of Emission Reductions

### ***Parameters and assumptions used in the Monte Carlo method***

Uncertainty in estimates of emission reductions were quantified using a Monte Carlo approach, based on 10,000 random permutations of model parameters (Table 8). The parameter values for AD in the monitoring period are an average of the activity data for 2019 and 2020, as they are calculated in the same way as the reference level AD (sum of area divided by number of years).

Several types of Probability Density Functions (PDFs) are used as part of the Monte Carlo simulation. These are:

- t-distribution: Emission factors for FSD and FSSV vegetation classes
- Normal: Emission factors derived from IPCC defaults (cropland, grassland, other land use)
- Uniform: Default root:shoot ratio, for species where local data are not available.
- Non-parametric bootstrapping: Used for activity data.
- Triangular: Carbon fraction derived from IPCC defaults.

In each of these cases, the distributions were selected for their suitability for the data source.

#### *Root to shoot ratio*

A uniform distribution is used for estimation of BGB for species where specific local allometric models aren't available (derived from IPCC given the range 0.27 - 0.28). Without further information provided, a uniform distribution was selected for its conservative nature.

#### *Carbon fraction*

The triangular distribution used for the carbon fraction was selected to account for the asymmetric nature of the uncertainty range associated with the IPCC default used (0.47 (0.44 - 0.49)). In any case, emissions estimates show very little sensitivity to changes in this parameter (see sensitivity analysis), so it would not be expected that any reasonable alternative PDF would have any impact on overall uncertainties.

#### *Emission factors*

FSD/FSSV emission factors use a t-distribution to account for low sample sizes. IPCC tier 1 emission factors are presented with a nominal estimate of error equivalent to two times the standard deviation, for which a normal distribution is considered a reasonable PDF.

#### *Activity data*

Uncertainties for activity data were captured using non-parametric bootstrapping, where sample units were resampled (with replacement) from the Collect Earth points. This has the advantage of not needing to specify a PDF a priori, and removing the impact of generating impossible negative areas of deforestation where the uncertainty range crosses 0.

The impact of this decision over two other reasonable approaches (a normal distribution, and a truncated normal distribution removing any negative deforestation areas) was assessed by comparison. In all cases the uncertainty ranges are almost identical, so any reasonable PDF would not be expected to have any impact on overall uncertainty of emissions.

Table 8: Parameter specifications used in the Monte Carlo simulations for the monitoring period.

Parameter included in the model	Parameter values	Error sources quantified in the model (e.g. measurement error, model error, etc.)	Probability distribution function	Assumptions
Carbon fraction	0.47	Measurement	Triangular (lower bound = 0.44, upper bound = 0.49, mode = 0.47)	(IPCC 2006)
Ratio of molecular weights of CO <sub>2</sub> and C	44/12			Default
Root to shoot ratio	0.275	Measurement	Uniform (lower bound = 0.27, upper bound = 0.28)	(IPCC 2006)
Length of reference period	11 years		-	ER program design
Project area	5310265.16 ha		-	ER program design
Area of FSD>(A O U) in reference period	1600.4 ha	Sampling	Non-parametric bootstrapping	
Area of FSD>C in reference period	129635.8 ha	Sampling	Non-parametric bootstrapping	
Area of FSD>P in reference period	19205.3 ha	Sampling	Non-parametric bootstrapping	
Area of FSSV>C in reference period	35209.7 ha	Sampling	Non-parametric bootstrapping	
Area of FSSV>P in reference period	1600.4 ha	Sampling	Non-parametric bootstrapping	
Area of FSD>C in monitoring period	27838 ha	Sampling	Non-parametric bootstrapping	
Area of FSD>P in monitoring period	288.7 ha	Sampling	Non-parametric bootstrapping	
Area of FSSV>C in monitoring period	2338.6 ha	Sampling	Non-parametric bootstrapping	

Area of FSSV>P in monitoring period	205.3 ha	Sampling	Non-parametric bootstrapping	
Aboveground biomass of FSD	144.7 t/ha	Sampling	t-distribution (mean = 144.7, sd = 16.33, df = 28.7)	
Aboveground biomass of FSSV	123.1 t/ha	Sampling	t-distribution (mean = 123.1, sd = 10.73, df = 5.2)	
Aboveground biomass of FF	269 t/ha	Sampling	Normal distribution (mean = 269, sd = 27.03)	
Aboveground biomass of C	10 t/ha	Sampling	Normal distribution (mean = 10, sd = 3.75)	
Aboveground biomass of P	2.3 t/ha	Sampling	Normal distribution (mean = 2.3, sd = 0.86)	
Aboveground biomass of (A O U)	0 t/ha	Sampling	Normal distribution (mean = 0, sd = 0)	
Belowground biomass of FSD	49.9 t/ha	Sampling	t-distribution (mean = 49.9, sd = 4.98, df = 25.99)	
Belowground biomass of FSSV	42.1 t/ha	Sampling	t-distribution (mean = 42.1, sd = 3.29, df = 4.01)	
Belowground biomass of FF	85.4 t/ha	Sampling	Normal distribution (mean = 85.4, sd = 10)	
Belowground biomass of C	0 t/ha	Sampling	Normal distribution (mean = 0, sd = 0)	
Belowground biomass of P	6.4 t/ha	Sampling	Normal distribution (mean = 6.4, sd = 3.9)	
Belowground biomass of (A O U)	0 t/ha	Sampling	Normal distribution (mean = 0, sd = 0)	

### **Quantification of the uncertainty of the estimate of Emission Reductions**

		Reporting Period	Crediting Period
		Total Emission Reductions	Total Emissions Reductions
<b>A</b>	<b>Median</b>	854,939.00	4,119,378.00
<b>B</b>	<b>Upper bound 90% CI (Percentile 0.95)</b>	2,686,370.00	6,773,196.00
<b>C</b>	<b>Lower bound 90% CI (Percentile 0.05)</b>	-911,583.00	1,567,323.00
<b>D</b>	<b>Half Width Confidence Interval at 90% (B – C / 2)</b>	1,798,976.50	2,602,936.50
<b>E</b>	<b>Relative margin (D / A)</b>	210%	63%
<b>F</b>	<b>Uncertainty discount</b>	15%	12%

### 5.3 Sensitivity analysis and identification of areas of improvement of MRV system

Sensitivity analysis was conducted by setting one parameter at a time to its nominal value, while retaining uncertainty of all other parameters generated from Monte Carlo (Table 9). The major contributor to uncertainty of ERs was Activity data for the reference period, followed by activity data for the monitoring period. Uncertainty from emission factors and carbon fraction was negligible.

The obvious target for reduction of the uncertainty of the ER estimates would be improving the Reference Level AD uncertainty. The MRV Unit is capable of conducting this improvement, which would rely on post-stratification of deforestation and application of updated QA/QC protocols, which have been improved upon since the collection of the reference data. However, FCPF guidelines preclude technical corrections of the Reference Level after validation and first verification ([link](#)).

The relative margin and uncertainty discount for 2019/2020 considerably higher than that achieved in 2018 (Table above: *Quantification of the uncertainty of the estimate of Emission Reductions*). While the absolute uncertainty for this reporting period is similar to that achieved in 2018, the lower emissions reductions for 2019/20 results in a higher uncertainty as a proportion of emissions reductions. For this case model sensitivity analysis (Table 9) highlights that options to meaningfully reduce the relative margin are very limited.

Table 9: Sensitivity analysis for the monitoring period.

Sensitivity test	Uncertainty estimate					Reduction in confidence interval (%)
	Median	Lower bound (5th percentile)	Upper bound (95th percentile)	Half-width confidence interval at 90%	Relative Margin	
Nominal	854939.3	-911583	2686370	1798976	2.1	0
AD (reference)	875278.2	-28532.6	1748277	888404.8	1.01	50.6
AD (monitoring)	850040.2	-680278	2487509	1583893	1.86	12
EF AGB	849735.6	-882786	2664281	1773533	2.09	1.4
EF BGB	855646.4	-916491	2687772	1802132	2.11	-0.2
CF	866176.7	-914759	2703818	1809289	2.09	-0.6

## 6 TRANSFER OF TITLE TO ERS

### 6.1 Ability to transfer title

In Mozambique, the main legal and regulatory frameworks concerning to the land and forests that support the Program Entity ability to transfer title to ERs are: **The Constitution of the Republic of Mozambique (CRM, 2004), the Law on Forests and Wildlife (1999), the Land Law (1997) and the REDD+ Decree (2018)**. The REDD+ Decree provides all the principles and procedures to be respected for the design and implementation of the ER Program. It deals with, inter alia: (i) the institutional framework, which is greatly clarified; (ii) the process for the approval and issuing of licenses for projects involving carbon credits and the procedures for the approval of REDD+ projects, putting great emphasis on community consultations; (iii) **establishes the uncontested ownership of ER titles to the State of Mozambique**; and (iv) **details administrative procedures for the management of the ER Transactions Registry and the REDD+ Project and Data Management Registry**.

In Mozambique, **Carbon is a State property** - Carbon is a constituent element of forests. If carbon is seen a constituent part of all natural resources, which exists per se, current constitutional and sectorial legislation is adequate for establishing that ownership over carbon resides with the State. The starting point is Article 98 of the CRM, of which the clause 1 clearly states: *"Natural resource in the soil and the subsoil, in inland waters, in the territorial sea, on the continental shelf and in the exclusive economic zone shall be the property of the State"*. In addition, Article 102 of the CRM goes on to say that "The State shall promote the knowledge, surveying and valuing of natural resources, and shall determine the conditions under which they may be used and developed subject to national interests".

The concept of "use and development" of natural resources - The intention of the Constitution in this overall context is clear: **the State as owner shall determine how natural resources are "used and developed" and, further, this determination can include selling the natural resource once it has gone through this process of "use and development"**. In other words, the carbon can be sold if it is subject to some sort of **conversion or transformation into a marketable commodity**. In the specific context of natural forests, which are State property, and which are in the public domain, the key legislation is the 1999 Forest and Wildlife Law (Law 10/99), which gives mandated agencies in the Government the right to assess requests to "use and develop" natural resources.

**ERs are products of "use and development" of carbon natural resources** - Precisely, ERs can be seen as a product of this "use and development" process. ERs are not a natural resource, conversely to carbon: they are the outcome of a decision by the State and/or others with rights over natural resources, and can only be produced by a transformational process or action implying to reduce deforestation and forest degradation. As such, they could be considered as "environmental commodities", identifiable and marketable in their own right. As a consequence, the CRM and existing natural resources laws are sufficient for determining ownership of ERs through the application of the "use and development" concept: the "user and developer" of the natural resources (in this case, forest carbon stocks) implements activities that result in ERs being produced.

**Until recently, State ownership of ERs was only clearly established by law for those generated within conservation areas.** Although this right seems clearly established for conservation areas such as the GNR where, in principle there will be few, if any, other pre-existing rights or claims over the resources in question, this may not have been true for other types of areas. In this situation, potential claims of rights on the ERs could have led the GoM to negotiate partnership or intermediation agreements with potential DUAT holders. Given the unfamiliar nature of the carbon and ER issues, it was therefore forecasted that specific legislation could greatly clarify the question of title and ER sales.

**The REDD+ Decree clearly establishes State property on all ER generated in the country (Articles 4 and 6):** although non-state DUAT holders and communities will have to benefits from the sale of ERs generated in the country, through specific benefit sharing plans, no formal agreements will need to be reached between each individual DUAT holders or local communities and the State. However, they will have to be properly consulted, as per national law. In order that the process has been implemented, taking into account national legislation, several meetings have taken place, between 2018 and 2019, from where 564 individuals participated in 6 consultation events at national, provincial and district level. The main objectives of these consultations were to discuss the program approach, the percentages of benefit allocation to each group of beneficiaries, allocation models/processes, priorities areas and benefits sharing challenges of the Benefit Sharing Plan (BSP). For further details of public consultations, please see on the following site below<sup>10</sup>:

As such, the REDD+ Decree clarifies the **"legitimacy and ownership of the State in the creation, generation, emission, validation, verification and withdrawal of emission reductions and corresponding titles of emission reductions" (Article 4)**. As such, in the current ER Program in Mozambique, the State retains control over the remaining natural forests and ownership over the ERs that are generated and the GoM, promoting behavioral change on the part of forest users, and is therefore free to sell the titles over these ERs, following the arguments presented above. Furthermore, the ability of the State of Mozambique to dispose of ER titles as financial products that can be traded is established in the REDD+ Decree, which states that ER titles **"may be disposed of, transferred to national and international exchanges of environmental and financial assets, under the applicable laws and standards and within the limits of the current national legislation"** and that such ER titles

---

<sup>10</sup>

<https://docs.google.com/spreadsheets/d/1LOo1dvQyUOXMHOU20Djg61E3ECM7OgDbJEhf68jPZ5c/edit?usp=sharing>

**“may also be transferred and offset in future under the international agreements concluded by the State of Mozambique within the framework of its international competences and its commitments and cooperation programs with public and private entities” (Article 15).** In the same way, Article 7 of the REDD+ Decree confirms that, for the implementation of REDD+ programs and projects, “The government can sign compensation agreements with international partners”.

Admittedly, the overall ability of the State to transfer the titles over ERs requires these ERs to be monitored, reported, verified and certified accordingly with UNFCCC procedures and FCPF CF methodological guideline. The discussion of certification and negotiations underlines how the Ministry of Economy and Finance (MEF) is really the entity able to enter into international negotiations over ER titles transfers, whenever the ERs are generated. As stated in the REDD+ Decree, **“The Ministry responsible for the financial sector is the legitimate issuer and manager of the Titles of Emission Reductions, being able to create and manage property rights, including the validation, verification, emission, transfer, transaction and withdrawing of the titles of emission reductions at national and international level” (Article 6).** In the context of the ER Program, the MEF was therefore the ER Program entity authorizing the ER Program and signing the ERPA with the FCPF CF. According to the administrative and legal procedures, the title of ERs is registered and ERs certificates issued by the MEF, after validation and verification of the monitoring report, provided by FNDS. Until now, MEF has not ER Transaction Registry established. However, FNDS is committed to working with the MEF, this year, in order to speed up the process of registering transactions. **As such, the MEF will be responsible the sale of ERs to the Carbon Fund.**

This REDD+ Decree clarifies the institutional arrangements for the implementation of REDD+ projects in Mozambique and clearly specifies the responsibilities of the FNDS and other key institutions. The institutional arrangement for the ER Program will fully respect the layout describes in the REDD+ Decree. According to the REDD+ Decree, The Ministry of Economy and Finance (MEF) is responsible for signing the Emission Reduction Payment Agreement (ERPA) with the FCPF CF ERPA and management of ER Titles transfer. FNDS will work closely with the MEF after the verification process, in order to provide technical support on this process.

Prior to the establishment of ZILMP, there was a VCS REDD project, called the Gilé National Reserve REDD Project, which was developed in the buffer zone of the Gilé National Park<sup>11</sup>, Zambézia Province (Figure 12). This Park is managed by the National Administration of Conservation Areas (ANAC). It is a national public agency that is responsible for the management of protected areas, and the project proponent of the above REDD Project.

This project was originally designed to have a crediting period of 20 years, from January 1, 2012, until December 31, 2031. However, once the ZILMP project was being developed, it became clear that, since the GNR project was fully included in the ZILMP program area, it would no longer be able to generate Carbon Credits from the date of the start of the ZILMP project. This is made clear in the project’s PDD<sup>12</sup>. The project was successfully validated for the monitoring period of 01-January-2012 to 31-December-2016. It is currently inactive for the duration of the ZILMP ERPA. This project is registered in the (<http://bit.ly/sistemaregistoREDD>). Several meetings between ANAC and FNDS have occurred in order to prevent double counting and a conflict of interest between the two REDD Programs.

Other than the Gilé National Park REDD Project, the program has not become aware of an inability or any contesting party during this reporting period, also there has not been any challenge, no one disputing the REDD+ decree and no title contested”.

---

<sup>11</sup> Previously it was known as the Gilé National Reserve

<sup>12</sup> Sections 1.8.5 and 1.12.4 of joint PD & monitoring report (doc. Ref. 1) <https://registry.verra.org/app/projectDetail/VCS/1674>

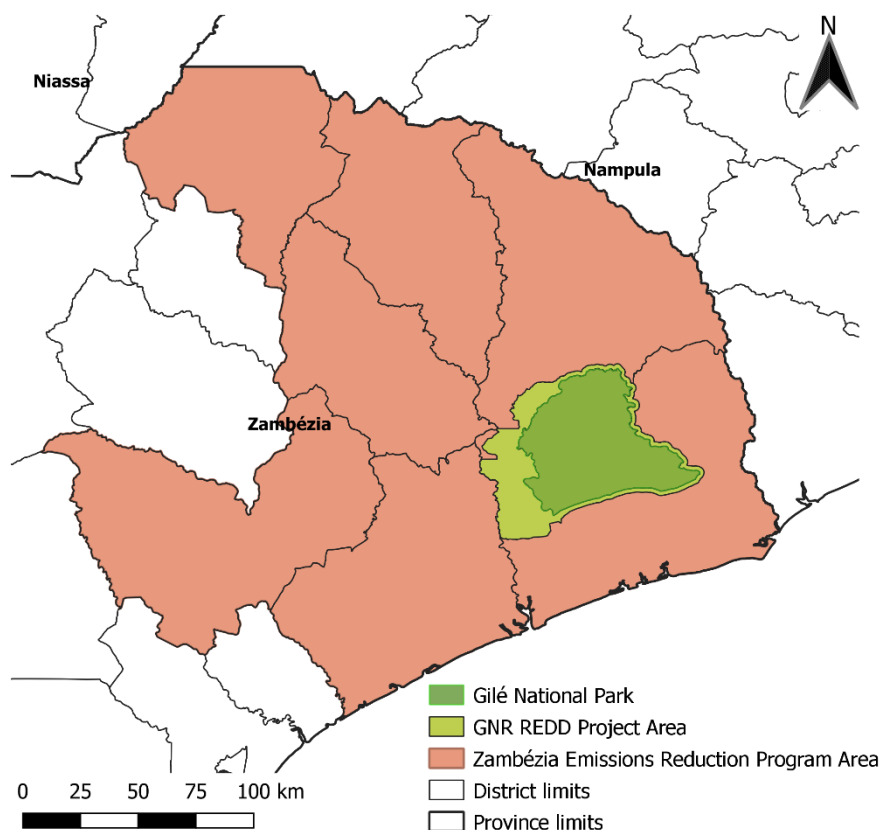

Figure 12: Location of GNR Project Area (buffer zone of Gilé National Park) and Zambézia Emissions Reduction Program Area.

## 6.2 Implementation and operation of Program and Projects Data Management System

The National Fund for Sustainable Development (FNDS) will be in charge of supervising and coordinating the ER Program at central level. As such, in the REDD+ Decree, the FNDS is confirmed as the entity in charge of approving all REDD+ programs and projects in Mozambique and in charge of managing REDD+ resources. As clarified in the REDD+ Decree (Article 10), the FNDS supports all institutions engaged in REDD+ policies. Its main responsibilities are:

- a. Establish, operationalize and ensure the maintenance of the components of the National MRV System;
- b. Propose and approve standards and technical methodologies for establishing the levels of reference, the monitoring, the evaluation of emission reductions, the reporting, the verification and the validation of REDD+ programs and projects;
- c. Receive, assess and evaluate the REDD+ projects proposals and annual monitoring reports;
- d. Monitor the reduction of greenhouse gas emissions and the achievements of ERs objectives of REDD+ projects;
- e. Management of the Safeguards Information System (SIS), including the REDD+ Feedback and Grievance Mechanism (FGRM);
- f. Enable the dissemination of data and relevant information on REDD+ projects, which should be made public respecting the policies of intellectual property privacy established with the different actors; (vii) To disseminate all information on the Programs and Projects and their social and environmental safeguards, Dialogue Mechanism and Complaints on existing platforms and their benefit sharing plan. With regard to the ER Program, the FNDS will therefore play a crucial role in the monitoring of the ERs generated by the ZILMP and of the safeguard policies - see section 14. In addition, and importantly for the ER Program, as stated in the REDD+ Decree (article 10) the FNDS is responsible for

- g. Managing the national REDD+ Programs and Projects Data Management System and for
- h. Communicating to the entity in charge of the ER Transactions Registry all information related to ERs generated by REDD+ projects – this is the MEF.

According to the REDD+ Decree (article 10), the **FNDS will be responsible for managing the national REDD+ Programs and Projects Data Management System** and for communicating to the entity in charge of managing the ER Transactions Registry (who will be the MEF, according to the same decree – Articles 14 and 26) all information related to ERs generated by REDD+ projects, including by the Zambézia Emission Reduction Program.

Mozambique is developing and implementing its own comprehensive national REDD+ Program and Projects Data Management System. The system is hosted and managed by FNDS as per de REDD+ decree “the FNDS is responsible for (vi) managing the national REDD+ Programs and Projects Data Management System and for (vii) communicating to the entity in charge of the ER Transactions Registry all information related to ERs generated by REDD+ projects”. Currently the system is implemented through a WebGIS platform (<https://bit.ly/srppmozfnds>) alongside with the NFMS and the projects M&E Web portal. The system is still under development, as currently Mozambique only has one ER program.

The actual Content of the REDD+ Program and Project Data Management System is below:

- The proponent of the ER Program or project;
- Geographical boundaries of the ER Program or project;
- Scope of REDD+ activities and Carbon Pools;
- The Reference Level used;
- MRV data to specific REDD+ projects/programs; and
- Safeguards plans in specific REDD+ projects/programs

### 6.3 Implementation and operation of ER transaction registry

As mentioned at 6.1, in this report, only after the approval of the REDD + decree in 2018, this is the first program to be implemented in the country. For this reason, it is still preparing to implement and operationalize the registration of ER transactions for future programs. Thus the GoM has decided to use a centralized ER Transaction Registry managed by a third party on its behalf: **the GoM will use the FCPF ER Transaction Registry.**

### 6.4 ERs transferred to other entities or other schemes

The Zambézia Emission Reduction Program is the first REDD+ program that occurs in Mozambique, after the approval of the Monitoring report and according with Contract ER, the volume will be transferred to the FCPF CF on a 100% basis. No ERs will be transferred to other entities during the crediting period.

As mentioned in section 6.1, there is a prior REDD project within ZILMP, but it is currently inactive and only generated Emission Reductions from 1 January 2012 to 31 December 2016.

## 7 REVERSALS

### 7.1 Occurrence of major events or changes in ER Program circumstances that might have led to the Reversals during the Reporting Period compared to the previous Reporting Period(s)

>> Intentionally left blank



## 7.2 Quantification of Reversals during the Reporting Period

<b>A.</b>	<b>ER Program Reference level for this Reporting Period (tCO<sub>2</sub>-e)</b>	<i>from section 4.1</i>	"Intentionally left blank"	
<b>B.</b>	<b>ER Program Reference level for all previous Reporting Periods in the ERPA (tCO<sub>2</sub>-e).</b>	<i>from previous ER Monitoring Reports</i>	"Intentionally left blank"	+
<b>C.</b>	<b>Cumulative Reference Level Emissions for all Reporting Periods [A + B]</b>		"Intentionally left blank"	
<b>D.</b>	<b>Estimation of emissions by sources and removals by sinks for this Reporting Period (tCO<sub>2</sub>-e)</b>	<i>from section 4.2</i>	"Intentionally left blank"	
<b>E.</b>	<b>Estimation of emissions by sources and removals by sinks for all previous Reporting Periods in the ERPA (tCO<sub>2</sub>-e)</b>	<i>from previous ER Monitoring Reports</i>	"Intentionally left blank"	
<b>F.</b>	<b>Cumulative emissions by sources and removals by sinks including the current reporting period (as an aggregate accumulated since beginning of the ERPA) [D + E]</b>		"Intentionally left blank"	-
<b>G.</b>	<b>Cumulative quantity of Total ERs estimated including the current reporting period (as an aggregate of ERs accumulated since beginning of the ERPA) [C - F]</b>		"Intentionally left blank"	

H.	Cumulative quantity of Total ERs estimated for prior reporting periods (as an aggregate of ERs accumulated since beginning of the ERPA)	from previous ER Monitoring Reports	"Intentionally left blank"	—
I.	[G – H], negative number indicates Reversals		"Intentionally left blank"	
If I. above is negative and reversals have occurred complete the following:				
J.	AMoUnt of ERs that have been previously transferred to the Carbon Fund, as Contract ERs and Additional ERs		"Intentionally left blank"	
H.	Quantity of Buffer ERs to be canceled from the Reversal Buffer account [J / H × (H – G)]		"Intentionally left blank"	

### 7.3 Reversal risk assessment

The reversal risk assessment using the CF Buffer Guidelines has changed since the preparation of the revised final ERPD. Due to the COVID situation, the Validation and Verification Body (VVB) was not able to conduct a country visit which could constrain the assessment process. However, it was identified that the assessment of the Risk Factor “Lack of broad and sustained stakeholder support” could not be concluded with a reasonable level of assurance without a country visit. In order to solve this, the reversal risk for this factor has been changed to the highest possible, at 10%.

It is important to note that the estimate provided in the revised final ERPD is conservative as required by the Carbon Fund Participants through resolution [CFM/17/2018/1](#).

Risk Factor	Risk indicators	Default Reversal Risk Set-Aside Percentage	Discount	Resulting reversal risk set-aside percentage
Default risk	N/A	10%	N/A	10%
Lack of broad and sustained stakeholder support	<ul style="list-style-type: none"> <li>Existence of a transparent Benefit Sharing Mechanism</li> <li>Existence of legal mechanism for the systematization of community consultation</li> <li>Signature of MoU with implementing partners</li> <li>Existence of a Feedback and Grievance Redress</li> </ul>	10%	Reversal risk is considered High: 10% discount	10%

	<p>Mechanism during the ER Program implementation, likely to generate the implementation of long-term efficient practices beyond the project life time</p> <ul style="list-style-type: none"> <li>● Existence of consultative forums and platforms involving various stakeholders with concrete and immediate perception of benefits, likely to make consultation become a long-term concern (including out of the scope of the ER Program)</li> <li>● Implementation of an efficient and large enough land titling and delimitation process to ensure stability of land rights in the long run</li> </ul>			
<b>Lack of institutional capacities and/or ineffective vertical/cross sectorial coordination</b>	<ul style="list-style-type: none"> <li>● Existence of designated and empowered relevant structure for ER Program implementation</li> <li>● Experience in multi-sectorial project implementation</li> <li>● Experience of collaboration between different levels of government</li> <li>● Existence of dedicated mechanism or body for inter-sectorial cooperation</li> <li>● Support from additional projects and programs for institutional capacities strengthening</li> <li>● Deployment of relevant staff on the ground</li> <li>● Training for long-term capacities on forest management and monitoring</li> </ul>	<b>10%</b>	Reversal risk is considered Medium: 5% discount	5%
<b>Lack of long term effectiveness in addressing underlying drivers</b>	<ul style="list-style-type: none"> <li>● Experience in decoupling deforestation and degradation from economic activities</li> <li>● Support from completing projects and programs oriented on deforestation and forest degradation reduction</li> <li>● Existence of a relevant legal and regulatory environment conducive to REDD+ objectives in the long run</li> <li>● Creation of relevant incentives for adoption of sustainable agricultural practices in the long run, including beyond the project lifetime</li> <li>● Clear perception of non-carbon benefits for stakeholders at long term and especially beyond the terms of the ERPA</li> <li>● Deployments of efficient and committed extension-agents at long-term</li> <li>● Adaptation of promoted sustainable practices to local constraints and dynamic in order to make it possible for them to be maintained in the long run</li> <li>● Potential administrative changes are expected to be progressive and participatory. But potential</li> </ul>	<b>5%</b>	Reversal risk is considered High: 0% discount	5%

	<p>risk may exist due to the fact that the ER program area doesn't cover the whole Province and additional coordination might be required.</p> <ul style="list-style-type: none"> <li>Well defined structures to ensure ensures the continuation of the ER Program beyond government term</li> <li>Pre-identification of financing sources</li> </ul>			
<b>Exposure and vulnerability to natural disturbances</b>	<ul style="list-style-type: none"> <li>Vulnerability to fires, storms and droughts</li> <li>Capacities and experiences in effectively preventing natural disturbances or mitigating their impacts</li> <li>Promotion of climate smart agricultural practices</li> <li>Existence of a Pest Management Plan</li> </ul>	<b>5%</b>	Reversal risk is considered High: 0% discount	5%
			<b>Total reversal risk set-aside percentage</b>	35%
			<b>Total reversal risk set-aside percentage from ER-PD or previous monitoring report (whichever is more recent)</b>	35%

## 8 EMISSION REDUCTIONS AVAILABLE FOR TRANSFER TO THE CARBON FUND

A.	Emission Reductions during the Reporting period (tCO <sub>2</sub> -e)	<i>from section 4.3</i>	875,578.1
B.	If applicable, number of Emission Reductions from reducing forest degradation that have been estimated using proxy-based estimation approaches (use zero if not applicable)		0
C.	Number of Emission Reductions estimated using measurement approaches (A-B)		875,578.1
D.	Conservativeness Factor to reflect the level of uncertainty from non-proxy based approaches associated with the estimation of ERs during the Crediting Period	<i>from section 5.2</i>	0.15
E.	Calculate $(0.15 * B) + (C * D)$		131,336.7
F.	Emission Reductions after uncertainty set-aside (A – E)		744,241.4
G.	Number of ERs for which the ability to transfer Title to ERs is still unclear or contested at the time of transfer of ERs	<i>from section 6.1</i>	0
H.	ERs sold, assigned or otherwise used by any other entity for sale, public relations, compliance or any other purpose including ERs that have been set-aside to meet Reversal management requirements under other GHG accounting schemes	<i>From section 6.4</i>	0
I.	Potential ERs that can be transferred to the Carbon Fund before reversal risk set-aside (F – G – H))		744,241.4
J.	Total reversal risk set-aside percentage applied to the ER program	<i>From section 7.3</i>	0.35
K.	Quantity of ERs to allocated to the Reversal Buffer and the Pooled Reversal Buffer (multiply I and J)		260,484.5
L.	Number of FCPF ERs (I – L).		483,756.9



## ANNEX 1: INFORMATION ON THE IMPLEMENTATION OF THE SAFEGUARDS PLANS

### I. Environmental and Social Aspects of ER Programs

The implementation of safeguards within the scope of ERPD complies with World Bank (WB) guidelines that are aligned with UNFCCC guidance related to REDD+. Some principles are defined as guidelines for compliance with the implementation of the project's environmental and social safeguards, respectively:

- (i) Compliance with legislation and good governance;
- (ii) Promotion of transparency and public/social responsibility;
- (iii) Respect the local culture and customary norms;
- (iv) Ensure meaningful participation by affected people and stakeholders (especially the most vulnerable);
- (v) Ensuring the existence of “auscultation” forms as conflict resolution mechanisms;
- (vi) Protect and conserve forests, contribute to the improvement of multiple forest functions;

In Mozambique the REDD+ readiness process went hand in hand with the preparation of the Social and Environmental Strategic Assessment (SESA).

Since 2015, the GoM is piloting a large-scale landscape program in part of the Zambézia province – the Zambézia Integrated Landscape Management Program (ZILMP) aiming to address the drivers of deforestation and degradation through an integrated landscape management approach. The landscape management approach recognizes the link between agricultural development, natural resource management and governance, both in terms of institutional management and practical implementation.

The present document is to provide evidence to demonstrate that the investment activities generating the ERs (from 2019-2020) meet the WB environmental and social safeguards. These investment activities are all financed by the following four World Bank investment projects:

- Forest Investment Project (MozFIP P160033, effective in August 2017)
- Mozambique Conservation Areas for Biodiversity and Development Project (MozBio P131965, effective May 2015)
- Agriculture and Natural Resources Landscape Management Project (Sustenta P149620, effective Nov 2016)
- Dedicated Grant Mechanism for local communities (MozDGM P161241, effective Feb 2018).

The above 4 investment projects represent the only REDD+ activities within the ER program area and they have the following safeguard instruments:

*Annex-Table 1: List of safeguard instruments approved and in place (Documents available in the link: <https://www.fnds.gov.mz/index.php/pt/documentos/salvaguadas-artigos>)*

Projects	Instruments	Duration
MozFIP	ESMF and PF Addendum <sup>13</sup>	2017 – 2022
MozDGM		2017 - 2023
MozBio 2 & GEF7	ESMF, RPF, PMP and PF	2015 – 2023
Sustenta	ESMF, RPF and PMP	2015 - 2021

<sup>13</sup> These two instruments were prepared to support the implementation of the MozFIP, MozDGM and other REDD+ initiatives and were based on the findings gathered during the elaboration of the SESA and the National REDD+ Strategy, financed by the Mozambique FCPF REDD+ Readiness Preparation Support (P129413).

All of the above-mentioned instruments have undergone consultations (summary of consultations available as annexes to the reports) and have been properly disseminated at central, provincial and local/district levels and are available online on both the FNDS website and the World Bank info shop.

In addition to these instruments, a land protocol and a protocol for preventing critical habitat conversion have been adopted to help address any potential land conflicts in land tenure regularization and unintended conversion of critical habitats respectively. Protocols available on the website: <https://sismdr.fnds.gov.mz/biblioteca>.

Effectively addressing the issues and complaints of individuals or groups affected by project activities is an essential component of operational risk management and FCPF requirements. Grievance redressing mechanisms are a way to prevent and resolve community concerns, reduce risk, and support processes that create positive social change.

In order to ensure a transparent and participatory process that contributes to the mitigation of risks related to possible conflicts in the implementation of REDD + initiatives, FNDS developed a common Grievance Redress Mechanism called the “Dialogue and Grievance Mechanism” for the projects that make up the Bank’s Integrated Landscape Management Portfolio in Mozambique (MozFIP, MozBio, and Sustenta). It is a system created to answer questions and complaints from individuals or groups affected by the project and program activities. Among other uses, it serves as an instrument to search for a harmonious relationship between affected and interested parties in the areas of implementation of projects and programs. The safeguards specialist based in the Landscape is the focal point for the FGRM in Zambézia province, and therefore responsible for receiving, processing, investigating and responding to the grievances reported in this province. The safeguards team prepared a manual of procedures, a communication strategy and a monitoring system for tracking grievances and assessing the extent to which progress has been made to resolve them, have already been prepared. The information about compliance stage can be found at the following link <https://sismdr.fnds.gov.mz/>.

The mechanism was discussed with key stakeholders, including local communities, and it is being implemented successfully.

Simultaneously, there is a continuous process of consultation and engagement involving different actors through the Zambézia Multi-Stakeholders Landscape Forum (MSLF). The link presents information on different phases and levels of consultations, where is highlighted the meetings with the Development Platform in the context of the preparation of the Benefit Sharing Plan and safeguard instruments: <https://docs.google.com/spreadsheets/d/1LOo1dvQyUOXMHOU20Djg61E3ECM7OgDbJEhf68jPZ5c/edit#gid=862126948>.

## **II. Monitoring and Reporting Requirements**

FNDS has developed monitoring and reporting procedures and templates that were deemed acceptable by the WB and used in the projects that make up the Bank’s Integrated Landscape Management Portfolio referred above. Monitoring consists of field visits and generation of quarterly evaluation reports submitted to the World Bank. The landscape safeguard team and the community development officer of Gilé National Park, supported by FNDS central safeguard team are responsible for this activity. In addition, the WB carries out supervision visits and Mid-Term Reviews every six months.

To effectively guarantee transparency, information is available, accessible and disseminated among the stakeholders. Specifically, for the Zambézia ER Program the most used way to share information including opportunities to participate in project activities, consultations and project performance results has been the Zambézia Multi-Stakeholders Landscape Forum (MSLF).

### **Investment activities compliant with the environmental and social safeguards**

The four WB projects in the program area include the following activities: (i) Integration of rural households into sustainable agriculture and forest-based value chains, (ii) restoring degraded areas, (iii) land delimitation and



tenure regularization, (iv) establishment of new planted forests/ the Planted Forest Grant Scheme (EFF)<sup>14</sup>, and (v) promotion of agro-forestry systems.

The activities are implemented by service providers and monitored by the PIU (Project Implementation Unit) that has a team of experts and extensionists, including a safeguards specialist. The Provincial Government (SPA and DPADT – Provincial Service of Environment and the Provincial Directorates for Environment and Territorial Development) are involved in the environmental assessment process of each subproject as per the national Environment Impact Assessment (EIA) Regulations. The district government is involved in the supervision of civil works, verifying compliance with labour and health and safety contract requirements. While, for implementation of MozDGM activities, the National Management Committee (CNG) was created and the World Wide Fund for Nature (WWF) was hired as a National Executing Agency (NEA), with the responsibility of increasing the participation of local communities and OCBs in Integrated Landscape Management; strengthening capacities for Community-Based Natural Resource Management; and Managing, monitor & evaluate the project.

Thus, proponents of community projects were supported in the improvement and detailing of the pre-selected community projects and carried out environmental and social screening of the 5 pre-selected community projects.

All WB investment activities undergo a review and screening process to determine the level of environmental and social assessment required. The screening and project categorization phase determines the necessary type of environmental and social management instrument to be developed for each activity, namely whether a Simplified Environmental Impact Assessment (ESIA), an Environmental and Social Management Plan (ESMP) or an Environmental and Social Management Good Practices Guide (ESMGPG) is required. Annex-Table 2 shows the list of activities implemented in the period of January 2019 to December 2020 in the program area, highlighting the status, including the categorization and the instrument prepared.

It is important to note that the majority of activities, mainly Agro-forestry systems (AFS), Forest Plantations, Agriculture (small emergent commercial farms) started in 2018, and the number of beneficiaries are increasing over the years.

All screening and licensing processes go through the validation of the WB safeguards team as a way to ensure compliance with their guidelines.

*Annex-Table 2: Environmental and social screening and safeguard plans prepared (Jan 2019 to December 2020).*

Subproject	Category	Instrument	Implementation phase
<b>MozFIP</b>			
Agro-forestry systems (AFS) in 42 communities in Zambézia Landascape	C	ESMGPG	Ongoing
Forest Plantation (EFF) (29 SMEs – Small and Medium Entrepreneurs)	C	ESMPGPG	Ongoing
<b>Sustenta</b>			
Agricultural development (11 SECF- Small emerging commercial farmers)	C	ESMGPG	Ongoing
<b>MozBio 1</b>			
Conservation agriculture, tree planting, nurseries in the Gilé National Park and the buffer zone	C	ESMGPG	Ongoing
Support non timber forest products value chains (beekeeping , basketry, ..) 2 communities in the buffer zone of GNP	C	ESMGPG	Ongoing

<sup>14</sup> EFF acronym in Portuguese.

MozDGM			
Participation of local communities and OCB in Management Integrated Landscape (5 Community projects selected and screened)	C	ongoing	ongoing

Parallel to the screenings, the process for environmental licensing of sub-projects is instructed in compliance with national legislation. The forest plantation sub-projects were classified as category C, with this oriented towards the elaboration of a Good Practices Manual which was harmonized with the Forest Management/Management Plan. As a result of the process, 25 environmental licenses were issued for a total of 29 beneficiaries, the remaining four being in process.

Screening of new areas for the 2020-2021 campaign began in the last quarter of 2020. Particularly for the FPS there is an attempt to involve young people, who can collaborate with large companies (Chazeira Mugoma, Chazeira Mozambique). To date, we have identified 10 young people to join the EFF, 10 potential trainees from Unizambeze and 2 potential nurseries.

The safeguards team produced a very simple and illustrative Environmental and Social Management Good Practices Guide for SECFs and AFS including basic environmental and social mitigation measures (Available in the link <https://fnnds.infordata.co.mz/biblioteca> : "Guia de boas praticas para agricultura e sistemas agroflorestais ". 200 guides on good practices (ESMGPG) in agriculture and agroforestry systems were distributed to extension workers, community facilitators, SDAE's (District Service for Economic Activities) technicians, and the same guides are being distributed to beneficiaries gradually.

### **Safeguard Compliance Levels**

Overall, the supervision and technical missions to the WB projects have systematically found that the measures identified by the safeguards instruments (ESMF, RPF, PF and PMP) have been properly implemented to prevent, minimize and mitigate environmental and social risks and impacts in a manner that is satisfactory to the World Bank Safeguard Policy. This is evidenced in particular by the design and implementation of key and innovative tools:

- (i) A generic Good Practice Manual (GPM) for emerging commercial agricultures and agroforestry systems producers;
- (ii) A protocol to avoid conversion of critical habitats;
- (iii) A land protocol;
- (iv) A protocol for community readiness; and
- (v) An online system to track the progress of safeguards documents processes. Moreover, whenever FNDS projects have faced constrains (e.g. delays in submitting safeguards sub-instruments), the team has been quick to react and improve compliance (i.e. submission of timely quarter reports and regular coordination meetings with the WB).

During this period (2019-20) an independent third party carried out a mid-term environmental audit, that was planned in the project preparation. The safeguards execution audit process to assess the level of performance of this component was completed and the audit report produced. The document presents the level of safeguards execution, which considers the beginning of the project and based on the instruments approved and aligned with the financing agreement between the Mozambican Government and the World Bank, and presents recommendations for improving the implementation of safeguards within the scope of the project.

The report presents a positive assessment of 82% Compliance out of a total of 34 requirements assessed, which includes performance in sub-project licensing, monitoring processes, Grievance Redress Mechanism, Pesticide management etc. In terms of training, the assessment was satisfactory with 63%.

The document was shared with the BM, Service Providers, PIU's and other implementing partners such as AQUA. This document is available on the FNDS website.

It was confirmed during project supervision missions that no works have started without ESMPs or Good Practice Manual (GPM) and that the environmental and social information and clauses are being included in the bidding documents and contracts, respectively. Despite the efforts made to comply with the WB safeguards policies, there are always challenges, especially in view of the quantity, variety and location – remote and disperse – of most subprojects. Thus, it is still necessary to continuously strengthen the capacity of FNDS to monitor the implementation of ESMP, Pest Management Plan (PMP) and GPM by the contractors, service providers and beneficiaries.

The issue of safeguards and REDD+ are still new in the landscape. The main challenges are related to the low level of literacy of most beneficiaries, which requires constant awareness to engage in the fulfilment of safeguards. Another challenge is to identify and use the clearest and simplest language possible.

The safeguards issue has been introduced at the beginning of the presentation of the project on the Zambézia Multi-Stakeholders Landscape Forum (MSLF), beneficiaries and district government.

Setting up safeguards for service providers and training extensionists has been the most used way to overcome the challenge. To this end, the FNDS team annually develops and implements a safeguards training program for government (SDAE- *District Service for Economic Activities*, SDPI- *District Service for Planning and Infrastructure*, DPTADER- *Provincial Service of Environment and the Provincial Directorate of Environment and Territorial Development (DPADT)*, DPASA- *Provincial Directorate of Agriculture and Food Security*, SPFFB- *Provincial Directorate of Forest and Wildlife* and GNP - *Gilé National Park*) partners (COSVI, ETC Terra, RADEZA, SESC, R-GCRN) including contractors and service providers. The training program is very practical, focusing on improving the capacities to properly implement the safeguard instruments.

Under MozFIP activities, during the period 2019/20 1097 individuals were trained, with 221 and 179 women standing out in 2019 and 2020, respectively. The trainings were about several themes and approaches focusing on inductions on environmental and social safeguards, Grievance Redress Mechanism, land conflict management and prevention of conversion of critical habitats. The MozDGM conducted a training of 12 trainers on Community Governance of Natural Resources, is available in the following website: <https://drive.google.com/drive/folders/1EequpLPTJHhrwun0sVxQGxmtt2-YhRy5?usp=sharing> and in <https://mozdgm.org.mz/>. Under SUSTENTA, 3 training sessions were held in various matters of socio-environmental safeguards, both for the technical team at the central level and PIUs, and 3 inductions were carried out for the beneficiaries of the subprojects (startups, MSMEs, PACEs).

Two visits were carried out, in August and December 2020, in order to assess the level of implementation of the activities planned for this year, assess the projections of the District Governments, discuss the Benefit-sharing Plan, participatory MRV and in particular the local initiatives to reduce deforestation in the Zambézia landscape, as well as discuss the Benefit Sharing Plan. Monitoring visits were carried out to 48 PACEs and 6 MSMEs.

A public presentation of the current version of the Benefit Sharing Plan was held at the III Plenary Session of the Zambézia Platform, on December 13, 2019. 85 participants were present, 71 members and 14 guests, out of which 23 were women.

The Annex-Table 3 below illustrates the summary information of the safeguards action in the ongoing activities.

*Annex-Table 3: On the ground safeguards activities implemented in the Zambézia Landscape.*

Activities	Safeguard Action on the Ground	Compliance
<p><b>Agroforest System (Gurué= 17 Communities, Mulevala= 16 Communities e Mocubela= 9 Communities</b> 1,524 farmers were involved in a total area of 931.495ha.). Of this number 32% are women, with 490 in the three districts.</p>	<ul style="list-style-type: none"> <li>Mapping and ground-truthing sensitive habitats for identifying protection and restauration activities (critical habitats, riverine forest, water springs, steep slopes, etc.);</li> </ul>	<p>In progress</p>

<p>7 contracts were established with nurseries, and 76,335 seedlings (41,178 fruit trees, 32,875 nitrogen fixing plants and 2,300 E.Citroadora) were distributed.</p>	<ul style="list-style-type: none"> <li>· Surveillance and monitoring the cleaning of farm fields (“machambas”) to ensure no uncontrolled cutting of trees (preservation deforestation, protect red list species and some forest species at risk e.g. umbila/wild teak - <i>Pterocarpus angolensis</i>, black wood- <i>Dalbergia melanoxylon</i>).</li> </ul>	
<p><b>Forestry Plantations (EFF)</b> (529,478 seedlings were distributed and 514 Ha of commercial plantations were planted, corresponding to 56% of the contracted area for the 2019/2020 campaign, benefiting a total of 59 plantation owners [14 individuals, 7 SMEs, 4 Associations (1 with collective Duat) and (3 holding an individual DUAT and with a total of 36 members), and 1 educational institution])</p>	<ul style="list-style-type: none"> <li>· Mapping, protection/recovery of about 10 hectares of critical habitats (riverside forest, water bodies, distinct erosion; native forest plots with some status of degradation...) and 90 hectares for the EFF (continuous process). To this end, restoration by stakes has been tested, with native species of umbila (<i>pterocarpus angolensis</i>) and chamfuta (<i>Afzelia quanzensis</i>);</li> <li>· Quarterly monitoring visits to plantation areas for supervising and assessing the performance of safeguard aspects linked to grant payments</li> </ul>	<p>In progress</p>
<p><b>Sustainable Agriculture</b> (54 Emerging Small Commercial Farmers - PACE's and and 25 Youth PACE's with 3.687Small farmers - PA's supported) 583.50 hectares of area were restored in the districts of Alto Molocue, Gilé, Gurué and Mocuba, corresponding to 39 properties of PACEs.</p>	<ul style="list-style-type: none"> <li>· Training and raising awareness on environmental and social good practices to beneficiaries;</li> <li>· Training on pesticide use and awareness for the correct disposal of out of date pesticides including support for final disposal of pesticide packaging from suppliers.). The training includes Integrated Pest Management (IPM) techniques: (i) Biological Control (ii) Cultural and Crop Sanitation Practices (iii) Chemical Control</li> </ul>	<p>In progress</p>
<p><b>Community projects</b> (inputs distributed and technical assistance provided to about 1,300 community members in the buffer zone of the Gilé National Park – tree owners, beekeepers, charcoal makers and small farmers)</p>	<ul style="list-style-type: none"> <li>· Raising awareness and environmental education programmers carried out on sustainable natural resource management involving more than 10,000 community members;</li> <li>· Production and dissemination of documentaries and songs on conservation of forest resources</li> <li>· Identification and preservation of 6,000 trees, in particular <i>Fabaceas</i>,</li> </ul>	<p>In progress</p>
<p><b>Community organization:</b> Community Creation and legalization of 14 CBNRM</p>	<ul style="list-style-type: none"> <li>· Training and raising awareness on environmental and social aspects;</li> </ul>	

<p>organizations in the buffer zone of the Gilé National Park was supported and 2 forest management plans were elaborated which includes the identification of the potential of non-timber forest products for communities in Gilé and Mulevala districts;</p> <p>5 CBNRM supported to elaborate Project Business Plans for community natural resources management projects in Mulevala, Gilé, Mocubela, Mocuba and Maganja da Costa.</p>	<ul style="list-style-type: none"> <li>· Reinforcement of gender mainstreaming and participatory governance</li> <li>· Training on the operationalization of the Dialogue and Grievance Mechanism and dissemination of spots through community radios of Mocuba, Gilé and Maganja da Costa and placement of giant posters.</li> </ul>	In progress
<p><b>Land Tenure Regularization</b> (250 communities were delimited; 162 Community Certificate issued; 155 Community Land Use Plans elaborated; and 153 Community Development Plans (Agenda) elaborated; and 83353 titles issued until December 2020)</p>	<ul style="list-style-type: none"> <li>· Field visits and interviews to monitor social community preparedness and the creation of community committees;</li> <li>· Site observation of the level of community engagement in the elaboration of community maps through Participatory Rural Approach (PRA);</li> </ul>	In progress (finalize and hand over the land titles and community certificates)

During the period corresponding to this report there was no record of new environmental and social risks.

#### Grievance Redress Mechanism in place and fully operational

A Grievance Redress Mechanism called the “Dialogue and Grievance Mechanism” that is a common mechanism for the projects that make up the World Bank Integrated Landscape Management Portfolio in Mozambique (MozFIP, MozBio, MozDGM, and Sustenta). The instruments above were tested before being approved by the World Bank. The Annex-Table 4 below summarize the registered cases from January to December in 2019 and 2020, in the Zambézia landscape.

*Annex-Table 4: Summary of conflicts in the Zambezia Landscape*

<b>Event Summary</b>		
	<b>2019</b>	<b>2020</b>
Registered cases	<b>61</b>	<b>61</b>
Claims	34	37
Suggestions	1	2
Consultations	6	15
Land conflicts	19	6
Not proceeding	1	1
Need clarification	0	0
<b>Stage of occurrences</b>		
Resolved	52	120
Ongoing	9	18
<b>Occurrence by project</b>		
MozFIP	29	28
SUSTENTA	32	33
<b>Occurrence by category</b>		
Project Performance	17	23

Social	42	27
Environmental	0	3
Not Classified	2	8

Additional information is available on the website: <https://sismdr.fnds.gov.mz/mdr/painel.php?ano=2020&projecto=15212263>. The Complaints were about land conflicts, in particular about the land tenure regularization process (individual titles and community certificates). Definition of limits was the main issue raised by project beneficiaries. Other complaints are related to delays in the delivery of agricultural inputs to SECF (Small Emerging Commercial Farmer) and AFS (agro forestry systems). Complaints about environmental issues are related to poor protection of sensitive habitats (riparian areas) and lack of knowledge about pesticide handling.

Regarding the management of land conflicts, until the end of 2020, 11 conflicts were registered in the conflict management system of the Service Provider for Land Regularization in the Zambézia Landscape of which 9 were resolved and the remaining 2 open and in process of resolution. The information is available through the link: <https://sites.google.com/site/verdeazullandscape/conflitos-seguimento>. Eight conflicts were presented by Verde Azul (Service Provider) for registration in the MDR, out of which 6 corresponded to the Zambézia Landscape, that required the attention of the safeguards team and were all resolved.

The conflict resolution system considers 3 levels of resolution: (i) between the parties involved with support from the local community leadership, local government, service provider and landscape safeguards (ii) between the parties involved with the support of FNDS safeguard specialist at central level (iii) between the parties involved with support of independent mediator Specifically, land conflict issues, when not resolved at community level with support of the FNDS, the SPGC and the conflict management office of the national land directorate are invited to support.

Until December 2020 almost 93% of the conflicts were resolved at local level with the support of community leaders, Landscape Safeguards and service providers.

To add to the above, there are traditional mechanisms for resolving complaints through local authorities (Community leaders). The MDR only responds to complaints about projects and community leaders are the main collaborators in resolving these conflicts.

### **Efficient and well trained safeguard team**

FNDS is responsible for overall strategic guidance and implementation of three of the four WB-funded projects (MozBio, MozFIP and Sustenta). The World Wildlife Fund for Nature (WWF) implements MozDGM.

Capacity building and training for Project Implementation Unit (PIU) was crucial in order to identify potential impacts of the project and determine appropriate environmental and social category of the subproject during screening phase.

FNDS has been accumulating experience and expertise in managing World Bank funded operations, particularly in climate change and natural resources management sectors. FNDS has the human resources - a team of four safeguards specialists at national level and one provincial safeguards specialist in the PIU in Zambézia province assisted by 1 community officer from Gilé National Park, 30 extensionists (agricultural value chains) and it is in the process of hiring 20 extensionists (15 to AFS and 5 to Forest plantation) - to oversee the MozFIP, MozBio and Sustenta – and sufficient project funds to adequately implement the safeguards instruments, including the GRM, and the monitoring and reporting framework.

MozDGM aims to increase the participation of communities and community-based organizations in landscape management, and to build their capacity to prepare and manage their own projects. Communities are receiving trainings to improve the quality and frequency of their participation in local decision-making bodies, as well as in technical areas to support sustainable resource management practices. WWF manages all project activities, including safeguards screening, implementation and monitoring. Their safeguards specialist is receiving safeguards training from the World Bank. FNDS provides support to project oversight as a member of the DGM National Steering Committee.

The safeguards team with the support of the WB safeguards specialist has been preparing safeguards training

program for the PIU staff, extensionists, and service providers to ensure that all the stakeholders involved in the subprojects received safeguards training before starting the implementation of project activities. In addition to these trainings, project beneficiaries participated in specific trainings on environmental and social good practices and the GRM.

The training plan is semi-annual; however, trainings are also carried out when individuals are hired to collaborate with the projects. All capacity building activities include, but are not limited to, the following: (i) training on the Environmental and Social Standards; (ii) GRM; (iii) Environmental and Social screening; (iv) Health and Safety; and (v) Pest Management Plan.

The beneficiaries of the training were NIRAS - Service Provider for the promotion of agroforestry systems and forest plantations; the community associations of Uapé and Nipiode; the beneficiary communities of the forest promotion scheme and agroforestry systems; the government representatives through District Permanent Secretaries, SPA, DPADT and SDAE's technicians. In the following link, will be found information on the topics, dates and places where the training took place: [https://drive.google.com/file/d/1V4wthH\\_6UJsnBdsn3MJ1GBHRPjNeRfCx/view](https://drive.google.com/file/d/1V4wthH_6UJsnBdsn3MJ1GBHRPjNeRfCx/view).

In collaboration with the World Bank, a specific training on the Gender Action Learning System - GALS's methodology was carried out in the community of Uapé, where 28 community members and 3 FNDS technicians including the safeguard technicians.

Specifically, in 2020, the training of FNDS technicians in the context of strengthening institutional capacity stood out:

- One (1) capacity building session carried out in collaboration with the WB which involved, in addition to the FNDS safeguards team, community development technicians from the CAs and 1 technician from MozDGM;
- Two (2) training courses led by the BM with the objective of ensuring the knowledge of the project implementing partners on the new safeguards' standards adopted by the BM, specifically the Environmental and Social Standards, designated as "NAS", from 1-20 April;
- Several training and awareness-raising sessions for the project's beneficiaries regarding COVID-19;
- Introduction to the GALS methodology - Gender Action Learning System

Finally, on December 8th and 9th, 2020, a meeting was held to harmonize the training plan for 2021 with service providers (Sofreco, MozBambu, Niras EFF and Niras SAF's).

Safeguards are a crosscutting issue and aspects of safeguards have been included in training on charcoal production, conservation agriculture and Non-timber forest products. These trainings benefited more than 1900 direct beneficiaries mainly in the buffer zone of the Gilé National Park and in the districts of Pebane, Mocubela and Maganja da Costa. The awareness on safeguard aspects included 12 schools in the buffer zone of Gilé National Park.

Particularly for the IPM, the focus is based on the increase capacity to extensionists and farmers, encouraged to work together to make experiments and come up with combinations that are suitable for the area.

Under the implementation of the ANRLMP/Sustenta and MOZFIP projects, the funnel lizard (*Spodoptera frugiperda*) was the most important pest, as it had a negative impact on corn crop and productivity, mainly in the 2017/2018 agrarian campaigns.

The IPM considers: (i) Biological Control that involves the use of biological agents and predators to control pests and diseases. The method was successful in crops like cassava. (ii) Cultural and Crop Sanitation Practices was improved, the farmers usually implement crop rotation and mulching technics; (iii) Chemical Control - These measures involved the use of insecticides to manage weeds, pests and diseases. For chemical control, systemic and contact insecticide - Belt (Flubendiamide 480g / L) 10 ml ampoules (48% Concentrated Suspension) has been used for an area of ½ ha, and for sesame the project has used/ Cyperimetrina 5-10% (250 ml bottle), also for an area of ½ ha.

In the forest plantation activity, there are some termites and the termicides fipronil and vega have been used to protect the plantations.

The IPM includes a control of birds, mainly done by using the traditional way of scaring (the use of scarecrows is

very common especially in cereal production areas), chasing and guarding of animals.

### III. SIS on the right track

The online platform for the Safeguards Information System (SIS) was developed and is operational. It is in the public domain and provides general information on safeguards, specifically, the Dialogue and Complaints Mechanism (number of registrations, stage of attendance, category, gender discrimination); existing operational instruments and information on the 7 Cancun safeguards in the Mozambican context for the forest program by providing information on how safeguards are being addressed and respected throughout the implementation of REDD+ activities. The SIS is simple, accessible, auditable, comprehensive and in line with national legislation and applicable World Bank and donor requirements; and oriented towards transparency and inclusion. The implementation of the SIS is taking a gradual and participatory approach. It is still an incipient process in Mozambique that requires well-structured coordination to enable the full participation of stakeholders (community, private sector, government, civil society).

The online platform for safeguards information in line with national legislation and the World Bank and donor requirements presents the following.

1. “Complementarity or consistency with national forestry programs and relevant international agreements” – MozBio, MozFIP and Sustenta subprojects aiming at the integration of rural households into sustainable agriculture and forest-based value chains, restoration of degraded areas, establishment of nurseries and new planted forests and promotion of agro-forestry systems in the Gilé National Park and its buffer zone are in line with the Sustainable Development National Program (2015-2030). It should also be noted that the implementation of AFS and the establishment of new-planted areas are key elements in the Action Plan of the REDD+ National Strategy, Reforestation National Strategy (2006-2026) and the Policy of Forestry and Wildlife Development (Resolution n.8/97 of April 1<sup>st</sup>). The operationalization of the protocol for preventing critical habitat conversion is an approach to comply with the national policy of biodiversity conservation and the convention of biological diversity of which Mozambique is signatory.
2. Transparent and efficient national forestry governance structures - FNDS is supporting the biannual assessment of forest operators to ensure their activities comply with national logging rules and propose correction measures when necessary. The most recent public report corresponds to the 2017 assessment (available on <https://fnds.infordata.co.mz/biblioteca>). In addition, the four WB projects are supporting the establishment and strengthening of the Communities Based in Natural Resource Management (CBNRM) committees. These committees are community organizational structures aiming at the sustainable management of natural resources. In the Gilé National Park and its buffer zone, the MozBio project created 14 CBNRM committees to ensure the conservation of the buffer zone of the greater forestry reserve in Zambézia province. MozFIP started strengthening capacity building for sustainable forest management in two community forest concessions in Gilé and Mulevala districts. MozFIP and Sustenta projects are supporting the CBNRM committees in the delimitation process and MozDGM plans a capacity-building program for communities in the ERPA area.
3. Respect for the knowledge and rights of local communities - All initiatives implemented take into account respect for local customary norms and habits. National legislation through Land Law and its regulation (Law 19/1997 of 1 October and Decree 66/99) and Forest and Wildlife Law (Law 10/99 of 7 July and Decree 12/2002 of 6 June) mention aspects to be considered in order to ensure respect and rights of local communities throughout the process of forest exploration and utilization particularly when referring to private sector investments for forest concessions or other investments that require the right to use and benefit from land. In the induction training to extensionists, service providers and all technical staff who have direct contact with the local communities, special attention is given to “community relations” including aspects to be respected in the communication with this target group, including best places to hold meetings, norms and customary habits.



4. Full and effective participation of stakeholders, in particular local communities: Effective participation in REDD + initiatives needs strong information and awareness raising campaigns, public consultations for subprojects and specific training programs. The landscape has an Integrated Development Platform where sustainable and integrated landscape development models and initiatives are discussed and harmonized among different stakeholders (representatives of local communities, civil society, local NGOs, provincial and district government) in regular meetings. The GRM is also an instrument that contributes to the full and effective participation of program participants.
5. Consistency with natural forests and biological diversity governance: The forest policy is currently being updated to improve the sustainable management of forest. Conversion of native forests to any activity, whether forest plantations, agriculture or other initiatives, is not eligible for receiving funding or grants by the projects in this landscape and the conversion of any natural habitat is strictly prohibited. The critical habitat conversion prevention protocol was developed to guide this particular aspect.
6. Actions to address risks of reversals: The adoption of new conservation agriculture techniques and the implementation of agroforestry systems allow the farmers to remain in the same area for several years. It is expected that, the landscape approach to integrated development contribute to the harmonization of sustainable practices of different landscape initiatives coordinated by different stakeholders.
7. Actions to reduce emissions displacement"- Monitoring and follow-up of activities is carried out with the support of the MRV unit which produces maps of landscape deforestation leading the different actors and stakeholders to know the deforestation stage particularly in their jurisdictional area and buffer zone. In addition, extensionists and the technical team of specialists from the project implementation unit at local level to ensure technical assistance and consequently the productivity of both small farmers and SAF producers carry out regular field visits. Land tenure regularization through DUATs titling is a model adopted in the landscape to ensure farmer presence in the same area. All initiatives are carried out with the support of the district government, which contributes to raising awareness and other aspects at community level. According to the information produced by the MRV unit, it can be seen that between 2017 and 2018, deforestation both in the area of implementation of the project and in the surrounding area has reduced. (Maps and additional information can be accessed through the link <http://www.fnds.gov.mz/mrv/>).

## ANNEX 2: INFORMATION ON THE IMPLEMENTATION OF THE BENEFIT-SHARING PLAN

### I. Requirements of FCPF on Benefit Sharing Plans

In 2018, the advance draft of the BSP was prepared but no payment was received to finance the implementation of BSP activities. The BSP was approved in February 2020. Between 2018 and 2019, 564 individuals participated in 6 consultation events at national, provincial and district level. The main objectives of these consultations were to discuss the program approach, the percentages of benefit allocation to each group of beneficiaries, allocation models/processes, priorities areas and benefits sharing challenges of the BSP. For more details, on how the activities are organized, please refer to the action plan at the end of the Annex 2.

The main modifications and updates in the approved version include:

- *Budget*: an increase in the operational costs to strengthen the project management team and include funds for supporting the implementation and monitoring of field activities.
- *Beneficiaries*: a modification regarding communities' eligibility was considered necessary. In the advance draft, only delimited local communities with forest cover were eligible. This criterion was considered too restrictive as less than 200 communities out of 1,700 would fulfil this condition by the end of the program. It was then decided that all communities within the ER project area were eligible. Concerning the forest cover, the 9 target districts have forest cover to a greater or lesser extent.
- *Flow of funds to beneficiaries*: this section was improved providing more details on how the funds will be transferred to the beneficiaries including the channels, allocation modalities and responsible entities.
- *Eligibility criteria and distribution modalities*: two main modifications were made in the allocation to communities. First, the allocation to communities continues to be performance-based but the approach has changed. In view of the large number of communities within the ER project area, it was not considered feasible to allocate funds to all the communities in the districts that achieve ER. The best option discussed during the consultations to benefit communities with sufficient funds to implement economic and social activities was the call for proposals. Second, the allocation of 10% of the community share to community capacity building to ensure communities acquire the necessary capacities to change their behavior and implement adequate land use practices to reduce deforestation and achieve targeted emission reduction. The approved BSP provides guidelines to implement these two new implementation modalities.
- *Monitoring*: a section on monitoring of ER program activities was added which includes responsibilities, reporting and financial audits.
- *Consultations*: this section was updated to include the consultations that took place in 2018 and 2019 and a table with the syntheses of the discussions.
- *Implementation guidelines*: an Annex was added with the implementation guidelines for the call for proposals component.

According to the detailed communication plan that was elaborated to ensure that the BSP implementation is widely disseminated for local communities in the field, several actions<sup>15</sup> will be carried out, such as spots and radio plays; Conducting interviews with program technicians, in local languages; production of booklets with figures; Interpersonal approach carried out by technicians from FNDS and SDAEs. Production of short videos with testimonials from beneficiaries. These videos will be disseminated through digital platforms, such as the FNDS website, social networks and at community meetings, in order to share examples of neighboring beneficiaries. The latest version of BSP booklet is available on the FNDS website.

---

<sup>15</sup> All materials will be translated into local languages!

## II. Monitoring and Reporting Requirements

### 1. Benefit Sharing Plan Readiness

1.1 The final version of the BSP was approved in February 2020. Between 2018 and 2020, draft versions were discussed with relevant stakeholders in several forums at national, provincial and district level. In 2018, a total of 4 consultations were carried out in the framework of the preparation of the BSP, respectively: (i) at the multi-stakeholder landscape forum (MSLF) of Zambézia, 2 (two) meetings involving representatives of local government, communities, private sector, NGOs; (ii) at the central level 1 (one) meeting with government representatives in the sectors of Land, Conservation Areas, Agriculture, Forestry, Mineral Resources and Energy, Rural Development, State Administration and representatives of the World Bank and; presentation during the V National Conference of Community Management. In the events 445 individuals participated, 30% of them were women, for more details, please see the link below<sup>16</sup>. The main objective of the meetings was to discuss the percentages of benefit allocation, allocation models/processes, priorities areas and benefits sharing challenges of the BSP. In 2019, two consultations took place. In November, the BSP was presented to civil society organizations with the following objectives: 1) To reach consensus on improving mechanisms for channeling and utilizing community benefits through access to and exploitation of natural resources; 2) To consider the impact of benefits already channeled to local communities and approaches to their improvement and 3) To share experiences among different actors in the local development process with the involvement of local communities and existing potentials. The allocation of 70% to local communities was highly appreciated by the participants. In general, civil society members showed interest and availability for building the capacities of local communities. In December, the approved version of the BSP was discussed with MSLF in Zambézia Province. The main issues discussed were related to i) the selection of proposal based on good practices in terms of governance and the sustainable use of natural resources by communities and CBOs, ii) starting date for ER payments and iii) sustainability of the ER Program. The approved version of the BSP was posted on [FNDS website](#) and the [WB portal](#). The Portuguese version is already available at the FNDS site. Brochures in Portuguese will be provided until December 2021, in order to ensure that all beneficiaries in particular local communities will be informed.

1.2 In addition to consultation meetings, where there was always an introduction to the meaning of REDD+ initiatives and what they represented for maintaining the role of forests in the conservation of soil, water and NTFPs and in improving the living conditions of communities, there were also 5 seminars, 2 in 2018 and 3 in 2019, with the aim of working on the annual plans with the provincial and district government. More details, can be seen in the link below<sup>16</sup>. Capacity building is a continuous process and therefore the main stakeholders will continue to be trained in order to improve the effectiveness of the BSP implementation. Furthermore, the BSP recognizes that communities need to acquire the capacities to change their behavior and implement adequate land use practices to reduce deforestation and achieve targeted emission reduction. The training will be based on issues related to the consolidation of governance systems, including own organization and strengthening in the sustainable management of natural resources and local business development. In order to reinforce the Communities in strengthening their governance and business development capacities. On the BSP action plan at the end of the Annex 2, several activities related with capacity building are previewed and Mulevala District was the first where CBOs were trained in 2020 and 2021. To this end, 10% of the community share (70% of the ER net payment) will be allocated to community capacity building and a Service Provider will be hired in due time for building the capacities of local communities in the program area. The community management network for natural resources has been identified as the potential provider of community training services

1.3 “Intentionally left blank”

---

<sup>16</sup>

<https://docs.google.com/spreadsheets/d/1LOo1dvQyUOXMHOU20Djg61E3ECM7OgDbJEhf68jPZ5c/edit?usp=sharing>

## 2 Institutional Arrangements

- 2.1 The institutional arrangements for the implementation and coordination of the BSP builds on existing mechanisms and respects the role and function of all institutions involved in REDD+ and forest management in Mozambique. The overall governance of the BSP includes: the Ministry of Economy and Finance (MEF); the Bank of Mozambique; FNDS (currently under the Ministry of Agriculture and Rural Development - MADER), including the Matching Grant Unit composed by a team of 5 members at central level supported by the Sustenta Project. The Investment Committee is an independent body constituted and operational to respond to all projects being implemented in the FNDS. Its main function is to deliberate on the submitted proposals. It consists of 6 members that include: a) Matching Grant Scheme (MGS) manager (no voting rights); b) academy representative; c) representative of SMEs; d) representative of the business community; e) Government representative; and representative of the financial sector. At Province level FNDS has the Projects Implementation Unit in Zambézia province, composed by 31 members. At Provincial Directorate of Land Development and Environment of Zambézia (*Direcção Provincial de Desenvolvimento Territorial e Ambiente da Zambézia – DPDTAZ*), we work with 2 technicians, 1 from the planning sector and 1 from the Forest Department and at the Provincial Service for the Environment (*Serviço Provincial do Ambiente – SPA*) level, we work with 2 technicians. In addition, 18 planning technicians of the SDAE and SDPI of each district and 2 from Gilé National Park are also involved. Finally, the Zambézia Multi-Stakeholders Landscape Forum (MSLF) composed by 70 members that belong to several public, private, NGOs, Academia, Social communication and community institutions. These implementing entities are resourced by several projects to carry out their respective responsibilities. Despite the activities being conducted by the above mentioned institutions, it is necessary to strengthen their skills in order to support the BSP implementation as well as to reinforce the ground team. More details can be seen on the BSP action plan at the end of Annex 2.
- 2.2 No regulatory or administrative approvals is required for implementing the BSP.
- 2.3 BSP stakeholders understand their obligations, roles and responsibilities. FNDS held at least 2 missions/year for each of the projects that contribute to the generation of ERs since 2018, and kept all relevant stakeholders aware of the Program and the BSP. In fact, there is great expectation of all stakeholders to receive the payment, since they know that deforestation rates have reduced in the program area. In addition, FNDS is currently preparing communication materials (brochures, posters, radio spots) to disseminate the BSP implementation modalities and to ensure that all relevant stakeholders are ready when the payments arrive. The timeline of the communication steps is indicated on the BSP action plan at the end of Annex 2. In order to ensure the incorporation of messages about BSP in the activities of projects implemented in the landscape, several materials are ready (Alignment with technicians from PIUs (including extension technicians), SDAEs and Service Providers). The detailed communication plan was reviewed and approved, different communication forms are envisaged for the different stakeholders<sup>17</sup>.
- 2.4 A Financial management assessment was undertaken by the World Bank, to evaluate the adequacy of the proposed project financial management arrangements, due to nature of this operation, to in particular determine whether FNDS – the Recipient’s - Dedicated Payment System, is acceptable to the Bank and to determine whether it has the adequate internal controls and oversight mechanism (e.g. audit) in place. The assessment revealed that there are adequate financial management arrangements at FNDS for the implementation of the project, specifically the management of the Dedicated Payment System. The assessment concluded that there is adequate capacity at FNDS which was established over the time on implementation of the Bank-financed operations. FNDS has experience in managing Bank-financed operations, and it is currently managing the following projects: Conservation Areas for Biodiversity and Development – Phase 2 (168802), Mozambique Forest Investment Project (P160033), Mozambique Agriculture and Natural Resources Landscape Management (P149620). However, the entity’s capacity will

---

<sup>17</sup> <https://www.fnds.gov.mz/index.php/en/our-projects/project-list/redd>

be reassessed during implementation support missions and strengthened as needed. No major Financial Management issues were raised under these projects. The overall Dedicated Payment System was assessed to be acceptable to the Bank, and the risk rating was assessed as Substantial due to country fiduciary risk, capacity issues in the country, in particular at provincial level, and decentralized nature of Dedicate Payment system. The first ER payment was received in August 2021. The funds will be used during the 4th quarter of 2021. The first BSP financial report will be provided at the end of January 2022.

2.5 The following accountability mechanisms are in place and functional: a Feedback [and Grievance Redress Mechanisms](#); independent third party monitoring under process, and a third party financial audit mechanism.

2.6 The Feedback and Grievance Redress Mechanisms (FGRM) is operational. This system records and addresses feedback and grievances related to the WB projects that contribute to emissions reduction in the program area. The FGRM, is a system created to answer questions, clarify issues, and complaints from individuals or groups affected by the activities under the program. The FGRM also serves as an instrument for pursuit of harmonious relationship between the parties concerned and interested in the areas of implementation of projects and programs. The information about registration and complaints attendance is available in an online platform and is updated continuously. Individuals and communities who believe they are adversely affected by the community and private sector initiatives implemented by the BSP will also use this mechanism. In 2020, 61 complaints related to WB project activities were received and all of them were satisfactorily resolved. This mechanism will be used for the BSP. Additional information on the FGRM can be found [here](#).

In addition to the FGRM, there is also a continuous process of consultation and engagement with involvement of different actors through the Zambézia Multi-Stakeholders Landscape Forum (MSLF). For more details, please see Annex 1.

2.7 FNDS has a team in place that is responsible for the ER program as well as for the BSP. At the national level is has a project coordinator, 6 MRV specialist, 2 safeguards specialists. At the provincial level the coordinator has already been identified. There is 1 safeguards specialist, and we are in the process of contracting another safeguards specialist . As soon as the BSP implementation begins, when and if necessary, the provincial team will be strengthened. According to the BSP, the positions planned for the technical support and administrative and financial management of the ER Program and BSP are: 1 manager, 4 technical assistants for MRV, a financial assistant, a Matching Grant technical assistant, a Safeguard technical assistant and a procurement assistant. Operational costs for running the ER Program and its BSP are estimated to reach 500,000 USD per year. This amount is deducted from the Gross Payment that the country will receive.

### 3 Status of Benefit Distribution

3.1 The 1<sup>st</sup> ER payment was received in August 2021. For the Monitoring report of 2019/2020 period no monetary and non-monetary benefits were distributed.

3.2 Due to the 1<sup>st</sup> ER payment only received in August 2021, no beneficiary received benefits for the Monitoring Period of 2019/2020. According with Fig.2 of BSP and the disbursement related to the 2018 ER Monitoring Report, the funds will be allocated in the following manner:

	% of monetary benefits shared	USD
Local Communities	70	4,069,437.93
Private sector (MGS)	20	1,162,696.55
Gilé National Park	4	232,539.31
9 Districts Governments	4	232,539.31
Zambezi Provincial Government	2	116,269.66
<b>TOTAL</b>	<b>100</b>	<b>5,813,482.75</b>

3.3 Due to the 1st ER payment only being received in August 2021, no beneficiary received benefits yet, for the monitoring period of 2019/2020. However, work is being done on the support and preparation of the teams that will assist in the process of convening and monitoring the reception of proposals, evaluating and assigning conditions for the projects to be implemented and their follow-up.

3.4 Regarding the effectiveness of the mechanisms for ensuring transparency and accountability during the implementation of the BSP, a Feedback and Grievance Redress Mechanism (FGRM) system was created to answer questions, clarify issues, and complaints from individuals or groups affected by the activities under the program. The FGRM also serves as an instrument for the pursuit of harmonious relationship between the parties concerned and interested in the areas of implementation of projects and programs. The information about registration and complaints attendance is available online platform and updated continuously. Individuals and communities who believe they are adversely affected by the community and private sector initiatives are also using this mechanism. A safeguards Information System (SIS) has been designed at the national level and will also report on the progress of the ER Program. The SIS will provide information on how the safeguards will be treated and respected throughout the implementation of the ER Program. When the funds are allocated, all the transferred benefits will be disclosed in the [ER program page](#).

As for the application and decision process on financing, for private sector, the Matching Grants Unit will receive the Proposals, analyze and ensure that they are in accordance with the criteria defined by the product and submit it to the decision of the competent body (Investment Committee). The Investment Committee is an Independent body that will make the final financing decision.

The provincial coordinator has already been identified. The hiring of a safeguards specialist is already in progress and the community management network for natural resources has been identified as the potential provider of community training services.

3.5 Due to the 1st ER payment being received only in August 2021, no benefit sharing distributions happened for the monitoring report period of 2019/2020.

3.6 There will be three monitoring channels:

- The first will periodic meetings with beneficiaries to monitor the status of implementation and satisfaction of beneficiaries;
- The second annual supervision activities will be carried out on the ground to check compliance with the contractual obligations relating to implementation of safeguards activities by service providers, private companies and other direct beneficiaries of the BSP; and
- The third is Feedback and Grievance Redress Mechanism (FGRM), described above.

3.7 Not applicable. The intention is to take advantage of the community's governance structure and strengthen the monitoring and follow-up mechanisms, as well as the development of capacities so that the communities can carry out the monitoring and evaluation as the process is being developed, in order to minimize the risks.

#### **4 Implementation of the Environmental and Social Management Measures for the BSP**

4.1 The measures that have been applied to manage environmental and social aspects resulting from the activities of implemented projects, such as safeguards instruments, protocols and the safeguards plan, can be seen in Annex 1 above. The community and private sector projects that will be implemented under the BSP will also follow the safeguards instruments, protocols and the safeguards plan.

## **5 Recommendations for BSP Improvement or Modifications.**

- 5.1 Due to the fact that the 1st ER payment was received in August 2021, it has not been yet allocated. Therefore, there are no changes to be made based on feedback from recipients. However, the BSP has been changed over the last 4 years, based on the results of consultations and discussions held at different levels, as can be seen in point 1 of annex 2.
- 5.2 As the payment was made in August 2021, we have not tested the payment procedures. However, we may experience bureaucratic delays.
- 5.3 Due to the large number of communities and possible proposals presented, there may be constraints in the analysis, approval and subsequent disbursement.
- 5.4 Please refer to the below mention BSP action plan.

Annex-Table 5: Benefit Sharing Plan Action Plan.

Activity	Deadline	Status	Observation
2° ER Monitoring Report (ER-MR)	31 of August	Under revision	Under revision
Assistance to government plans			
Support the inclusion of REDD+ activities in annual provincial and Districts Economic and Social Plans	Continuous	ToRs Development	Travel preparations for 9 districts to complete 2021 PESODs
Monitoring the implementation of district plans	Continuous	In progress	Monitoring the implementation of PESODs 2021
Support the inclusion of REDD+ activities in annual Gilé National Park	Continuous	In progress	
<b>BSP Dissemination</b>			
Translation of BSP	June 2020	Done	Final version available
Editing and producing a short version of the BSP	November 2020	Done	
Develop key messages to be harmonized and disseminated to different stakeholders	August/September 2020	In progress	Several materials are ready
Ensure the incorporation of messages about BSP in the activities of projects implemented in Landscape	Continuous	Started	Several materials are ready (Alignment with technicians from PIUs (including extension workers), SDAEs and Service Providers)
Produce and publicize radio plays	December 2021	In progress	For Local Communities
Organize a symbolic ceremony for the payment of the first tranche (with massive press coverage)	October 2021	In progress	For government at various levels, journalists and the general public
Produce a bilingual newsletter (Portuguese / English)	Continuous	Started	For donors and other audiences
Produce short videos with English subtitles (about success stories)	November 2021	Not started	For donors and other audiences



Project Implementation Manual - PIM			
Develop terms of reference	May 2020	Done	
Kick-off meeting	June 2020	Done	
Discussion and follow-up meetings	March/August 2021	Done	
Mapping communities and landscape CBOs			
Mapping the communities in the 9 districts of the Zambézia landscape	Continuous	In progress	Mapped communities. A total of 1700 communities are estimated in the 9 districts that belong of the landscape
Mapping the CBOs by district including information on the scope of each	Continuous	In progress	Zambézia platform collaboration was requested
Develop proposal for capacity building of CBOs of the landscape	October 2020	In progress	The training plan for CBOs will be based on the results of the ongoing training of CBOs in Mulevala and collaboration with MozDGM
Capacity building of communities/CBOs			
Develop ToRs for hiring CBO's trainers in the Mulevala district in matters related to sustainable management of natural resources and local business development	May 2020 and August/2021	Done	The received funds will be used for implementation of community development projects
Kick-off meeting	June 2020	Done	
Monitor training activities in collaboration with Community Based Natural Resources Management Network	Continuous	In progress	Increased the Contract period

Produce training booklets (community governance and sustainable use of natural resources)	December 2021	In progress	
Hiring of the BSP reinforcement team			
Develop ToRs for technical safeguards assistant	October 2021	In progress	
Develop ToRs for technical MGU and procurement assistant	October 2021	In progress	
Call for projects launched			
Technical sheet for call of community projects	July 2021	Done	
Disclosure of the Community Projects Financing Window	November 2021	Not started	
Assessment of the level of readiness of communities to access the call	October – November 2020	Cancelled	There was a change in the approach for financing community projects. All CBOs are eligible to apply for the call.
Produce registration / registration form for applications	November 2021	Not started	
Disseminate the finance window	November 2021	Not started	
Support the logistics of the selection process for potential beneficiaries	November 2021	Not started	
Support in the process of preparing investment plans	December 2021	Not started	
Perform screening and licensing of selected subprojects	December 2021	Not started	
Mapping of enterprises within private sector	September 2021	Continuous	
Selection of potential private sector companies	October 2021	Not started	
Call disclosure	November 2021	Not started	
Screening and licensing	December 2021	Not started	

Call launch	November 2021	Not started	
Preparation of the financial product data sheet (MGS) for the Private Sector	June 2020	Done	
Development of communication strategy and dissemination materials (pamphlets, etc.)	October 2021	In progress	
Monitoring the process of preparing and filling out proposals	December 2021	Not started	
<b>TOTAL</b>			

## ANNEX 3: INFORMATION ON THE GENERATION AND/OR ENHANCEMENT OF PRIORITY NON-CARBON BENEFITS

### Priority Non-Carbon benefits

1. In the area on the ER program is taking place, several activities that provide non-carbon benefits are taking place within the scope of the implementation of the MozFIP, SUSTENTA and MozBio projects. The list can be seen on the Annex-Table 6, below.

Annex-Table 6: List of the identified set of priority Non-Carbon benefits

Priority Non-Carbon Benefit	<ul style="list-style-type: none"> <li>● Details on activities for generation and enhancement                             <ul style="list-style-type: none"> <li>○ Approach (as defined in ERPD including relevant indicators)</li> </ul> </li> </ul>
Improvement of local livelihood through securing long-term access to forest resources and environmental benefits	
Increase of land areas under sustainable landscape management practices	<ul style="list-style-type: none"> <li>▪ Areas of multiple-use forests planted established under the Planted Forest Grant Scheme;</li> <li>▪ Restoration of degraded areas and protection of fragile habitats, included waters spring;</li> <li>▪ Areas of agroforestry systems established;</li> <li>▪ Gilé National Park under improved management plans and law enforcement, as measured by the Management Effectiveness Tracking Tool.</li> </ul>
Long term adoption of sustainable land use practices	<ul style="list-style-type: none"> <li>▪ Forest Plantations under the Planted Forest Grants Scheme;</li> <li>▪ Areas of agroforestry systems established;</li> <li>▪ Sustainable production of charcoal</li> <li>▪ Value chain development of non-timber forest products (NTFP)</li> </ul>
Clarified land tenure	Community land delimitations and registered parcels for DUAT emissions, and DUAT emissions for families
Strengthening of forest governance and forest resources management	
Improved forest governance and transparency	<ul style="list-style-type: none"> <li>● The approval of the National Land Use Plan, which is expected to foster proper land use planning, with land use decisions being based on transparent information and a consultative process on land use priorities;</li> <li>● Establishment of national Monitoring, Reporting and Verification (MRV) system</li> <li>● Patrol and inspection, prevention and detection of the forestry sector</li> <li>● The operationalization of the National Forest Information System, which is expected to improve information availability, accessibility and transparency, contributing to an effective forest monitoring and control;</li> <li>● Biannual evaluation of forest concessions to check the compliance of forest operators with management plans and other legal and basic sustainability requirements (fiscal obligations, social security, qualified rangers, concession contract, availability of statistical information, industrial plans, technical capacity, delimitation of area and harvesting blocks, etc.).</li> </ul>
Enhanced participatory forest and land use management	Consist of improved overall governance and access to information. Through the well-functioning of the Zambézia Multi-Stakeholders Landscape Forum (MSLF), it includes enhanced landscape-level dialogue and multi-stakeholder decision-making on the use of natural resources, contributing to integrated landscape management. Eventually, their ability to participate in decisions over

	natural resources can empower stakeholders and bring additional long-term benefits for resource management.
--	---

There is information available on the achievement of goals for the generation and / or appreciation of Non-Carbon Benefits in the progress reports of projects that took place at ZILMP, mainly from MozFIP<sup>18</sup> and MozBio<sup>19</sup> projects.

Annex-Table 7: The achievement of goals of the generation of Non-Carbon Benefits

Priority Non-Carbon Benefit	<ul style="list-style-type: none"> <li>● Details on activities for generation and enhancement               <ul style="list-style-type: none"> <li>○ Achievement of goals</li> </ul> </li> </ul>																												
Improvement of local livelihood through securing long-term access to forest resources and environmental benefits																													
Increase of land areas under sustainable landscape management practices	<p>Most of the activities under this Non-Carbon Benefits priority are part of component 1 of the MozFIP project. The fulfillment of the activities of this component can be seen in its 2019 and 2020 annual report, approved by the world bank. Based on this, the scope of the activities of component 1 was 15% and partial 85% in 2019. 2020, the component achieved 10% and Partial 90%. For more details, see the Link (<a href="https://www.fnds.gov.mz/index.php/pt/component/edocman/relatorio-balanco-ii-iii-trimestre-2019-MozFIP-fnds-final-071219/download">https://www.fnds.gov.mz/index.php/pt/component/edocman/relatorio-balanco-ii-iii-trimestre-2019-MozFIP-fnds-final-071219/download</a> )</p>																												
Long term adoption of sustainable land use practices	<p>Most of the activities under this Non-Carbon Benefits priority are part of component 2 of the MozFIP project. The fulfillment of the activities of this component can be seen in its 2019 and 2020 annual report, approved by the world bank. Based on this, the scope of the activities of component 2 was 32 % and partial 62% for 2020, 33% and partial 56%. For more details, see the Link (<a href="https://www.fnds.gov.mz/index.php/pt/component/edocman/relatorio-balanco-ii-iii-trimestre-2019-MozFIP-fnds-final-071219/download">https://www.fnds.gov.mz/index.php/pt/component/edocman/relatorio-balanco-ii-iii-trimestre-2019-MozFIP-fnds-final-071219/download</a>)</p>																												
Clarified land tenure	<p>This is also part of MozFIP component 1. 83 communities delimited and 16 529 land titles emitted.</p> <table border="1" style="width: 100%; border-collapse: collapse; text-align: center;"> <thead> <tr> <th></th> <th>2019</th> <th>2020</th> <th>Total</th> </tr> </thead> <tbody> <tr> <td>Communities delimited</td> <td>83</td> <td>187</td> <td>270</td> </tr> <tr> <td>PCUT</td> <td>68</td> <td>107</td> <td>175</td> </tr> <tr> <td>Unofficial certificates</td> <td>47</td> <td>106</td> <td>153</td> </tr> <tr> <td>RDuat</td> <td>18 344</td> <td>26 881</td> <td>45 225</td> </tr> <tr> <td>DUAT</td> <td>16 529</td> <td>19 880</td> <td>36 409</td> </tr> <tr> <td>Titles</td> <td></td> <td>17 189</td> <td>17 189</td> </tr> </tbody> </table>		2019	2020	Total	Communities delimited	83	187	270	PCUT	68	107	175	Unofficial certificates	47	106	153	RDuat	18 344	26 881	45 225	DUAT	16 529	19 880	36 409	Titles		17 189	17 189
	2019	2020	Total																										
Communities delimited	83	187	270																										
PCUT	68	107	175																										
Unofficial certificates	47	106	153																										
RDuat	18 344	26 881	45 225																										
DUAT	16 529	19 880	36 409																										
Titles		17 189	17 189																										
Strengthening of forest governance and forest resources management																													
Improved forest governance and transparency	The activities also are part of component 2. Please see above the progress in achieving Non-Carbon Benefits																												
Enhanced participatory forest and land use management	<p>This activity reached 33% and 32% in relation to what was planned for 2019 and 2020. For more details, see the Link (<a href="https://www.fnds.gov.mz/index.php/pt/component/edocman/relatorio-balanco-ii-iii-trimestre-2019-MozFIP-fnds-final-071219/download">https://www.fnds.gov.mz/index.php/pt/component/edocman/relatorio-balanco-ii-iii-trimestre-2019-MozFIP-fnds-final-071219/download</a>)</p>																												

<sup>18</sup> <https://www.fnds.gov.mz/index.php/en/our-projects/project-list/MozFIP>

<sup>19</sup> <https://www.fnds.gov.mz/index.php/en/component/edocman/mozbio-gile-sexto-relato-rio-de-progresso-180924-vf/download>; <https://www.fnds.gov.mz/index.php/en/component/edocman/mozbio-gile-se-timo-relato-rio-de-progresso-final/download>

Adapted from table 2, annex 1 of 2019 and 2020 annual MozFIP Report. Link:

[https://www.dropbox.com/s/qibzegs2m4xjmiz/Relat%C3%B3rio%20Balan%C3%A7o%20Anual%20de%202019\\_APROVADO.docx?dl=0](https://www.dropbox.com/s/qibzegs2m4xjmiz/Relat%C3%B3rio%20Balan%C3%A7o%20Anual%20de%202019_APROVADO.docx?dl=0) and  
[https://www.dropbox.com/s/n49lq01rpouw836/Relat%C3%B3rio%20Anual%202020\\_FINAL.docx?dl=0](https://www.dropbox.com/s/n49lq01rpouw836/Relat%C3%B3rio%20Anual%202020_FINAL.docx?dl=0)

## Other Non-Carbon benefits and additional information as linked to Monitoring and Evaluation Framework

### 1. Other (non-priority identified) Non-Carbon benefits

The activities that provided non-carbon benefits are activities that the beneficiaries were already developing, but in a more organized and technically oriented way. In this way, all of them are in line with their culture. These activities, although not presented by gender, the beneficiaries are the families where the whole household will benefit. Such as:

#### Livelihood enhancement and sustainability

Within the ER Landscape of Zambézia program to sustain and improve livelihoods is one of the main objectives. With the priority non-carbon benefits listed above, the following non-carbon benefits have been provided in the ER MR period 2019 and 2020. Due to the areas reached and the number of people involved, these medium and long-term benefits will make a difference in local communities' livelihood.

#### 1.1. The ER program achieved<sup>20</sup>:

- 2.1.1 453,35 ha with agroforestry systems established, including 1086 farmers from 3 communities were involved; and 263 ha of restored area.
- 2.1.2 268 Charcoal producers, organized in 4 associations in Pebane, Mocubela, Maganja da Costa and Ile;
- 2.1.3 Inputs distributed and technical assistance provided to about 1,300 community members in the buffer zone of the Gilé National Park – tree owners, beekeepers, charcoal makers and small farmers;
- 2.1.4 83 and 187 communities were delimited in 2019 and 2020, in an area of 359,692 ha in 2020 and 16,529 and 19,860 individual land uses rights issued respectively.

#### Biodiversity

- 1.2. In the ER program, two projects are testing ways to conserve biodiversity in the Gilé National Park: i) the Mozambique Conservation Areas for Biodiversity and Development Project (MozBio); and ii) the Forest Investment Project (MozFIP). The MozBio project contributed with financial and technical support the Gilé National Park and its buffer zone; while MozFIP has provided financial and technical support to the law enforcement activities in the Gilé National Park. The Gilé NR is a key biodiversity area in the landscape. In addition, the MozFIP and Sustenta projects are restoring degraded areas, which also contribute to the biodiversity conservation through the connection of forest fragments.

#### Protected/conserved areas

- 1.3. The ER Program area included the Gilé National Park (GNR), that covers an area of 2861 km<sup>2</sup> and 1671 km<sup>2</sup> buffer zone. The area has not changed.

---

<sup>20</sup> Sources of information: 1- Etc Terra-Rongead / IGF, Sétimo relatório de progresso Mozbio-Gilé, Dezembro de 2018 (<https://www.fnds.gov.mz/index.php/pt/documentos/relatorios/mozbio-gile-se-timo-relato-rio-de-progresso-final>); 2- MozFIP 2018 annual report (<https://www.fnds.gov.mz/index.php/pt/documentos/relatorios/mozbio-gile-se-timo-relato-rio-de-progresso-final>).

### Re/afforestation and restoration

- 1.4. Total reforested and restored area: Beneficiaries contracted
- 1.5. restored
- 1.6. households
- 1.7. ha

	2019	2020	Total	
Beneficiaries contracted (n)	32	112	144	
Planted area (ha)	92.5	300	392.5	
Restored (ha)	126,26	263	389,26	
SAF	Households	1528	1524	3052
	Ha	782	931,49	1713,49

### Finance and Private Sector partnerships

- 1.8. The program budget has not changed.

## **2. Other Non-Carbon benefits and additional information**

### Policy development

- 2.1. Under CF Program, through MozFIP project, the National Forest Policy, was developed and approved in early 2020.

### Capacity building

- 2.2. In the ER Program, three main beneficiaries were identified under the four WB projects (MozFIP, MozBio, SUSTENTA and MozDGM), namely, local communities, private sector and Zambézia provincial and 9 districts government. In 2019 and 2020, the beneficiaries involved were mainly, the local communities and Zambézia government:

During the report period, several training and capacity interventions involved local communities. The number and gender of people involved varied, depending on the type of activity, subject, place and time, as shown below:

In the Gilé National Park and its buffer zone<sup>21</sup>, in the subjects of charcoal production, conservation agriculture and non-wood forest products, some training actions were made. Such as recycling and training actions for the construction of improved charcoal works. To obtain greater efficiency in charcoal production and to reduce deforestation, 75 charcoal workers were involved, of which of them 12 were women; including 2 theater groups to present plays about the impact of uncontrolled fires and methods to control them, with 884 participants, of 4 areas, namely Namala, Naheche, Moneia and Mulela<sup>22</sup>. On the same theme, 920 people were sensitized, of which 300 were women. On Conservation Agriculture<sup>23</sup>, 327 people were trained on improved dryers, of which 64 were women; 2 producers from the community nurseries

<sup>21</sup> Source: Etc Terra-Rongead/IGF, Relatório final do projecto de progresso Mozbio-Gilé, 2016-2019, Outubro de 2019 (click <https://www.fnds.gov.mz/index.php/pt/nossos-projectos/listagem-de-projectos/mozbio> for more details).

<sup>22</sup> Etc Terra-Rongead / IGF, Nono relatório de progresso Mozbio-Gilé, Julho de 2019 (click [here](#) for more details).

<sup>23</sup> Etc Terra-Rongead / IGF, Oitavo relatório de progresso Mozbio-Gilé, Abril de 2019 (click [here](#) for more details)

supported by the INCAJU nursery team were trained in carrying out the grafting of cashew trees and mango trees. 1061 beneficiaries during the 2018/19 agricultural season (78% men and 22% women) were trained in the practice of conservation agriculture and followed by project technicians in their own agricultural field, with dissemination to 40 volunteer producers and receiving support technician

Under MozDGM, in 2019<sup>24</sup> and 2020, In Component 1 - Increased participation of local communities and OCB in the Integrated Management of Landscape at national, provincial and local level and Component 2 - Capacity Building for Natural Resources Management Based on Communities, some training occurred according with the table below:

*Training of community members in Zambézia Province*

Themes	2019	
	M	W
Forest management and legislation	10	
Carpenters	9	
Beekeeping	9	
Information and Communication Technologies	5	3

Source: Adapted from NEA – WWW report 2019

Strengthen capacity building for sustainable forest management in two community forest concessions in the districts of Gilé and Mulevala. 135 members were trained, of which 45% were women.<sup>25</sup>

The details that indicate culturally appropriate, and in particular the inclusion of gender, do not appear clearly, because in 2018, most of the description of activities did not detail this information as well as the number and gender of people involved. But this situation improved in the following years. However, some data has been made available, for example, on Gender disaggregation, mentioned on the periodical project reports (MozFIP, MozBio, SUSTENTA and MozDGM).

During the ER MR period, the following training actions were carried out for members of the provincial government of Zambézia and 9 districts:

One seminar/workshop, the third plenary session of the zambézia platform was held within the Integrated Landscape Management Program of Zambézia (ZILMP) area. It took place in Quelimane, with participation of 62 individuals, which 23 were women from several institutions<sup>26</sup>. One of the objectives was to discuss and sharing information on ERPA / ZILMP the benefit sharing plan.

During 2019, “on the job trainings” were held in the 9 MozFIP districts in Zambézia in May and August 2019, as well as the seminar on Geospatial planning tools in December, for district service technicians.

<sup>24</sup> NEA-WWF, Relatório de progresso narrativo e financeiro do Mecanismo de Doação Dedicado às Comunidades Locais no ano de 2019, Março de 2020 and NEA-WWF, Relatório de progresso narrativo e financeiro do Mecanismo de Doação Dedicado às Comunidades Locais no ano de 2020, Março de 2021

<sup>25</sup> Source: MozFIP 2019 annual progress report, MozFIP 2020 annual progress report

<sup>26</sup>

<https://docs.google.com/spreadsheets/d/1LOo1dvQyUJXMHOU20Djg61E3ECM7OgDbJEhf68jPZ5c/edit#gid=862126948&range=B81>



In the introduction training to extensionists, service providers and all technical staff who have direct contact with the local communities, special attention was given to “community relations” including aspects to be respected in the communication with this target group, including best places to hold meetings, norms and customary habits.

To date, all activities of the NCB have been carried out in compliance with the safeguards requirements and within the scope of the BSP should also continue to comply with the safeguards instruments, protocols and plans.

#### Other

##### Institutional Strengthening

With the implementation of the Safeguards Information System and the Dialogue and Complaint Mechanism, it allows for greater transparency in the process of implementing the emission reduction program and projects.

3.3 We do not yet have evidence with private sector partnerships. The partnerships are at beginning stage.

## **Annex 4: CARBON ACCOUNTING - ADDENDUM TO THE ERPD**

"Intentionally left blank"

## ANNEX 5: ER MONITORING REPORT (ER-MR) ON THE AREA OUTSIDE THE SCOPE OF ZAMBÉZIA INTEGRATED LANDSCAPE MANAGEMENT PROGRAM (ZILMP)

This annex was prepared as part of the Government's commitment to monitor and report in parallel the annual emissions reduction in the area outside the scope of Zambézia Integrated Landscapes Management Program (ZILMP) within the Zambézia province under the Emission Reductions Purchase Agreement (ERPA) signature.

### 5.1 CARBON POOLS, SOURCES AND SINKS

#### 5.1.1 Description of Sources and Sinks selected

Sources/Sinks	Included?
Emissions from deforestation	Yes
Emissions from forest degradation	No
Enhancement of carbon stocks	No
Sustainable management of forests	No
Conservation of carbon stocks	No

#### 5.1.2 Description of carbon pools and greenhouse gases selected

Carbon Pools	Selected?
Above Ground Biomass (AGB)	Yes
Below Ground Biomass (BGB)	Yes
Biomass in non-woody vegetation	No
Dead organic matter	No
Soil Organic Carbon (SOC)	No

GHG	Selected?
CO <sub>2</sub>	Yes
CH <sub>4</sub>	No
N <sub>2</sub> O	No

### 5.2 REFERENCE LEVEL

#### 5.2.1 Reference Period

The reference period is from 2005 – 2015 (11 years).

## 5.2.2 Forest definition used in the construction of the Reference Level

According to the national REDD+ strategy and to the Final Report on Forest Definition (Falcão and Noa, 2016) approved by MITADER in November 2016, forest in Mozambique is defined as followed: **minimum area of 1 ha, minimum height at maturity of 3 m and minimum tree cover of 30%.**

The previous GHG inventories used the previous forest definition of Mozambique (minimum area of 0.5 ha, minimum height of 5m and minimum tree cover of 10%). However, future GHG inventories will use the updated forest definition.

## 5.2.3 Average annual historical emissions over the Reference Period

### 1.1.2.1.1 Description of method used for calculating the average annual historical emissions over the Reference Period

The UNFCCC does not give any directives with regards to the reference period for the RL. However, the Forest Carbon Partnership Facility (FCPF) have specific guidelines, setting a minimum of 10 years and a maximum of 15 years. The chosen period for the construction of the RL is from 2005 to 2015, 11 years.

In accordance with the UNFCCC decisions, the method used to assess emissions is the one described in IPCC (2006) for Land (Forest land in the present case) converted to other land use (e.g., croplands, grasslands, etc.) consisting on the multiplication of activity data – area of land converted from forest land to other land (e.g., cropland or grassland in the present case) – by emission factors – difference of carbon stocks before and after deforestation – as presented on the following equations. The data used for the present document are Tier 2 (country specific data or country level estimates) or Tier 3 (data specifically produced for the ER Program) when possible. Activity data are produced on the reference period with spatially explicit method based on available satellites images. Emissions factors are derived from literature or forest inventory in the accounting area.

In compliance with criterion 13 of FCPF MF (FCPF, 2016) that specifies that RL should not exceed the average annual historical emissions, different activity data of the reference period will be averaged to produce annual deforestation areas over the whole period.

As analysis is done over the reference period, long term (11 years) changes (increase or decrease) of carbon stocks on deforested areas (land converted to another land use) are considered instead of annual increase or decrease - see the **Equation 16**.

Gross emissions of the RL from deforestation over the Reference Period ( $RL_{RP}$ ) are estimated as the sum of annual change in total biomass carbon stocks ( $\Delta C_{B_t}$ ) during the reference period as shown in the equation below.

$$RL_{RP} = \frac{\sum_t^{RP} \Delta C_{B_t}}{RP} \quad \text{Equation 15}$$

Where:

$$\begin{aligned} \Delta C_{B_t} &= \text{Annual change in total biomass carbon stocks at year } t; \text{ } tC \cdot \text{year}^{-1}; \\ RP &= \text{Reference period, years.} \end{aligned}$$

Following the 2006 IPCC Guidelines, the annual change in total biomass carbon stocks forest land converted to other land-use category ( $\Delta C_{B_t}$ ) would be estimated through the following equation:

$$\Delta C_{B_t} = \Delta C_G + \Delta C_{CONVERSION} - \Delta C_L \quad \text{Equation 16}$$

Where:

$$\begin{aligned} \Delta C_{B_t} & \text{ Annual change of total biomass carbon stocks during the period, in } tC \text{ per year;} \\ \Delta C_G & \text{ Annual increase in carbon stocks in biomass due to growth on land converted to another land-} \\ & \text{ use category, in } tC \text{ per hectare and year;} \end{aligned}$$

$\Delta C_{CONVERSION}$  Initial change in carbon stocks in biomass on land converted to other land-use category, in tC per hectare and year; and

$\Delta C_L$  Annual decrease in biomass carbon stocks due to losses from harvesting, fuel wood gathering and disturbances on land converted to other land-use category, in tC per hectare and year.

Following the recommendations set in chapter 2.2.1 of the GFOI Methods Guidance Document for applying IPCC Guidelines and guidance in the context of REDD+<sup>27</sup>, the above equation will be simplified and it will be assumed that:

- The annual change in total biomass carbon stocks ( $\Delta C_B$ ) is equal to the initial change in carbon stocks ( $\Delta C_{CONVERSION}$ );

Considering equation 2.16 of the 2006 IPCC GL for estimating ( $\Delta C_{CONVERSION}$ ) the change of biomass carbon stocks could be expressed with the following equation:

$$\Delta C_{B_t} = \sum_{j,i} (B_{Before,j} - B_{After,i}) \times CF \times \frac{44}{12} \times A(j,i)_{RP} \quad \text{Equation 17}$$

Where:

$A(j,i)_{RP}$  Area converted/transited from forest type  $j$  to non-forest type  $i$  during the Reference Period, in hectares per year. In this case, three forest land conversions are possible:

- (Semi-)deciduous forest to Non-forest type  $i$ ;
- (Semi-)evergreen forest to Non-forest type  $i$ ; and
- Mangrove forest to Non-forest type  $i$ .

Five types of non-forest land are considered:

- Cropland (C);
- Grassland (P);
- Wetland (A);
- Settlement (U); and
- Other lands (O).
- 

$B_{Before,j}$  Total biomass of forest type  $j$  before conversion/transition, in tons of dry matter per ha. This is equal to the sum of aboveground ( $AGB_{Before,j}$ ) and belowground biomass ( $BGB_{Before,j}$ ) and it is defined for each forest type.

$B_{After,i}$  Total biomass of non-forest type  $i$  after conversion, in tons dry matter per ha. This is equal to the sum of aboveground ( $AGB_{After,i}$ ) and belowground biomass ( $BGB_{After,i}$ ) and it is defined for each of the five non-forest IPCC Land Use categories.

$CF$  Carbon fraction of dry matter in tC per ton dry matter. The value used is:

- **0.47** is the default for (sub)tropical forest as per IPCC AFOLU guidelines 2006, Table 4.3.

44/12 Conversion of C to CO<sub>2</sub>

### 1.1.2.1.1.2 Activity data and emission factors used for calculating the average annual historical emissions over the Reference Period

#### Activity data

<sup>27</sup> [https://www.reddcompass.org/documents/184/0/MGD2.0\\_English/c2061b53-79c0-4606-859f-cf6c8cc6a83](https://www.reddcompass.org/documents/184/0/MGD2.0_English/c2061b53-79c0-4606-859f-cf6c8cc6a83)

<b>Parameter:</b>	$A(j,i)_{RP}$
<b>Description:</b>	Area converted from forest type $j$ to non-forest type $i$ during the reference period.
<b>Data unit:</b>	hectare per year.
<b>Source of data and description of measurement/calculation methods and procedures applied:</b>	<p><b>i. Approach and source</b></p> <p>Activity data for deforestation were obtained from an annual historical time series analysis of land use, land-use change and forestry (LULUCF) carried out by five trained operators in approximately 98 effective working days (4.4 months), for the period of 2001 – 2016 across the country, using the Collect Earth Open tool.</p> <p>Activity data have been generated following IPCC Approach 3 for representing the activity data as described in the 2006 IPCC Guidelines for National Greenhouse Gas Inventories (Volume 4, Chapter 3, Section 3.13), i.e., using spatially-explicit observations of land-use categories and land-use conversions over time across the country, derived from sampling of geographically located points. The result was forest cover data for 2016 and forest cover change data for every year from 2001 to 2016.</p> <p>The period of AD analysis from 2005 to 2015 (11 years) considered for the ER in the area outside the scope of ZILMP within the Zambézia province, could be adapted within the general period 2001 – 2016 with little effort, due to the operators collecting the date of the LULC change.</p> <p><b>ii. Sampling design</b></p> <p>A systematic 4 x 4 km grid consisting of a total of 48, 894 sampling points was established at a national level to generate the historical activity data for the entire area of the country using high and medium resolution imagery, which is the same grid used to allocate the NFI clusters from the Stratified Random Sampling design. At jurisdictional level, this corresponds to 2,984 points being interpreted. Each sampling point was visually assessed and its information was collected and entered in a complete database on LULC changes at the national level.</p> <p><b>iii. Response design</b></p> <p><u>Spatial sampling unit</u></p> <p>The spatial sampling unit from each point was defined as a point with a spatial support consisting of a 100m x 100m plot (1 ha), where an internal grid of 5 x 5 points (20m x 20m grid) is overlapped. Each point from the internal grid has a weight coverage of 4% (Annex-Figure 1).</p>



*Annex-Figure 1: Spatial sampling unit*

Source of reference data

The sampling approach for historical AD calculation based on the regular National 4 x 4 km grid has been designed and conducted using the high and medium resolution images repository available through Google Earth and Earth Engine as a visual assessment exercise. These imagery with digital forms (Annex-Figure 2) designed to collect the LULCC information on the points of the grid are automatically accessible through the Collect Earth tool ([www.openforis.org](http://www.openforis.org)) along with scripts accessible through Earth Engine code that facilitate vegetation type's interpretation (e.g. MODIS or Landsat NDVI time series). Each point of the grid is photo-interpreted thanks to Collect Earth tool and the year and type of changes are also collected.

The use of various scripts programmed on Earth Engine Code facilitates the interpretation of the vegetation type and the determination of LULC changes. Specifically, the MOD13Q1 (NDVI 16-day Global Modis 250 m) graphic from 2001-2016, most recent Sentinel-2 image, most recent Landsat-8 pan sharpened image, Landsat-7 pan sharpened image (2000, 2004, 2008, 2012), etc.

The completeness of the series is guaranteed using RS products from medium resolution imagery repositories from 2001 (e.g. Annual TOA Reflectance Composite, Annual NDVI Composite, Annual EVI Composite, Annual Greenest-Pixel TOA Reflectance Composite, etc. from Landsat 5 TM) and the most recent Sentinel-2 image from 2016. In this way, a temporal analysis of LULC changes has been completed for each sampling point of the national 4 x 4 km grid (48,894 records).

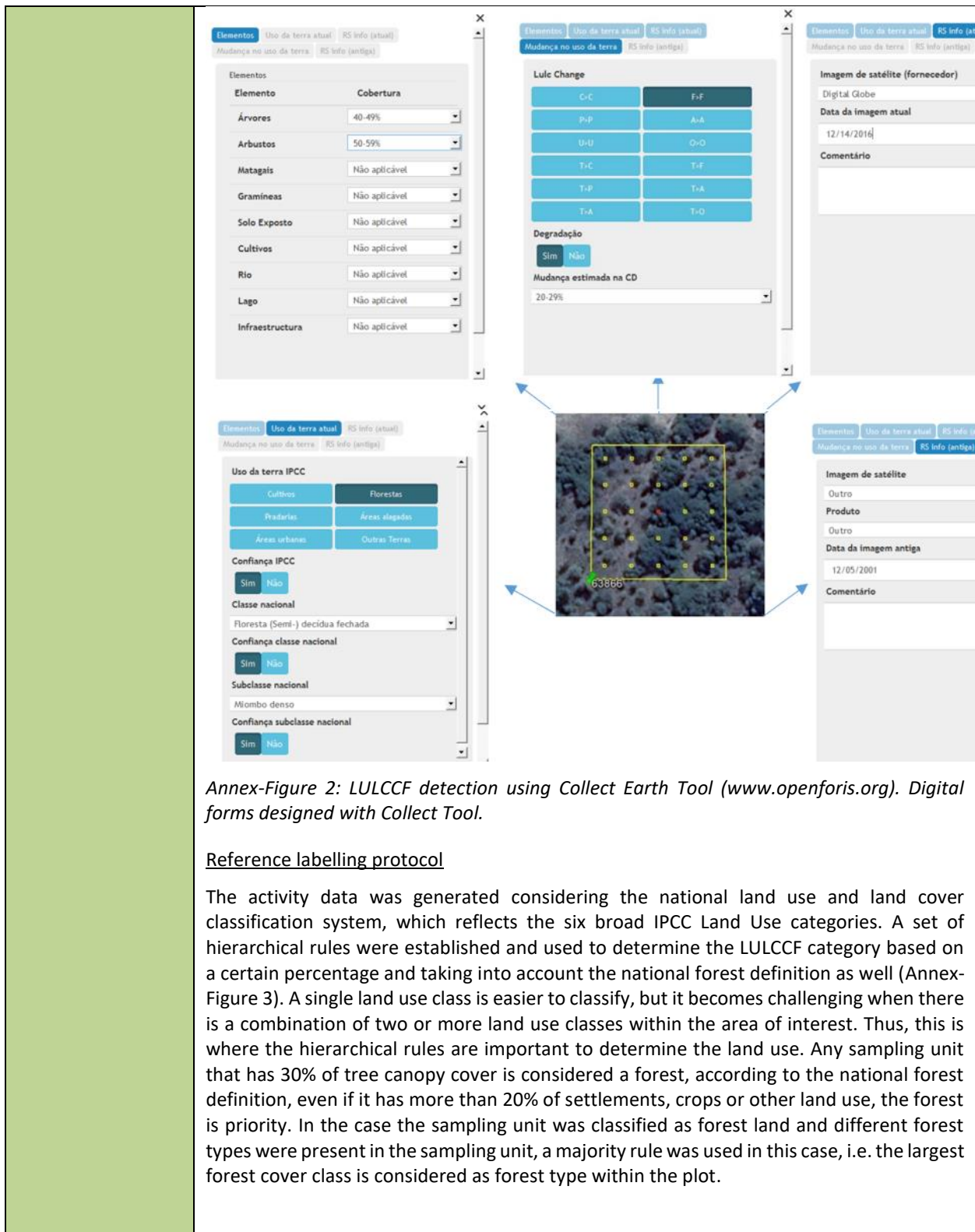

Annex-Figure 2: LULCCF detection using Collect Earth Tool ([www.openforis.org](http://www.openforis.org)). Digital forms designed with Collect Tool.

### Reference labelling protocol

The activity data was generated considering the national land use and land cover classification system, which reflects the six broad IPCC Land Use categories. A set of hierarchical rules were established and used to determine the LULCCF category based on a certain percentage and taking into account the national forest definition as well (Annex-Figure 3). A single land use class is easier to classify, but it becomes challenging when there is a combination of two or more land use classes within the area of interest. Thus, this is where the hierarchical rules are important to determine the land use. Any sampling unit that has 30% of tree canopy cover is considered a forest, according to the national forest definition, even if it has more than 20% of settlements, crops or other land use, the forest is priority. In the case the sampling unit was classified as forest land and different forest types were present in the sampling unit, a majority rule was used in this case, i.e. the largest forest cover class is considered as forest type within the plot.

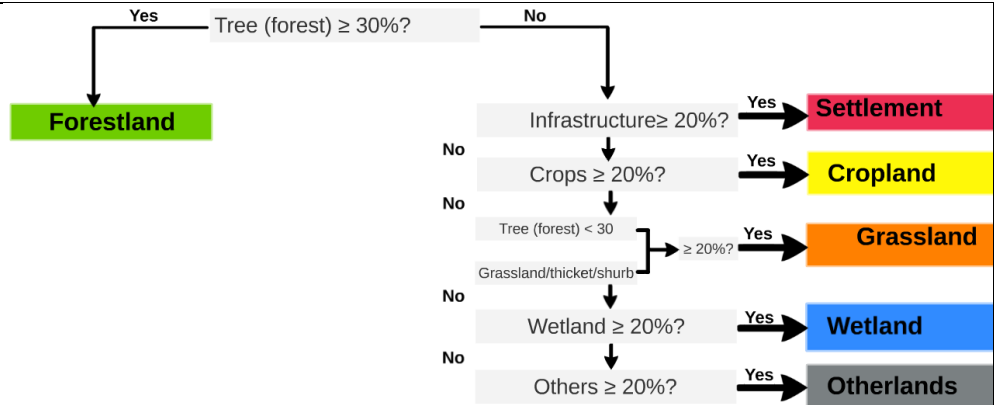

Annex-Figure 3: Decision tree for the attribution of the LULCCF category based on the percentage cover of the elements present in the sampling unit of 1 ha.

**iv. Analysis**

The estimation of the areas corresponding to a certain category changes from a forest type to a non-forest type in the framework of this systematic sampling approach was based on assessments of area proportions. According to 2006 IPCC Guidelines for National Greenhouse Gas Inventories (Volume 4, Chapter 3, Section 3.33), the proportion of each land-use or land-use change category is calculated by dividing the number of points located in the specific category by the total number of points, and area estimates for each land-use or land-use change category are obtained by multiplying the proportion of each category by the total area of interest, in this case, the area outside the scope of ZILMP within the Zambézia province.

$$A_i = p_i \times A \tag{Equation 18}$$

Where:  
 $A_i$  Area estimate on forest type  $j$  converted to non-forest type  $i$ ; hectare  
 $p_i$  Proportion of points on forest type  $j$  converted to non-forest type  $i$ ; dimensionless  
 $A$  Total area of interest; hectare

$$p_i = \frac{n_i}{N} \tag{Equation 19}$$

Where:  
 $n_i$  Number of points on forest type  $j$  converted to non-forest type  $i$ ; number  
 $N$  Total number of points; number

The standard error (ha) of an area estimate was obtained as (2006 IPCC Guidelines for National Greenhouse Gas Inventories, Volume 4, Chapter 3, Section 3.33):

$$e_i = A_i \times \sqrt{\frac{p_i \times (1 - p_i)}{N - 1}} \tag{Equation 20}$$

Where:  
 $A$  Area of interest, ha.  
 $p_i$  Proportion of points on land use change category  $i$ , dimensionless.  
 $n$  Number of sampling units, number.



	The 90% confidence interval for $A_i$ , the estimated area of land-use category $i$ , was given approximately by $\pm 1.64$ times the standard error.																						
<b>Value applied</b>	<table border="1"> <thead> <tr> <th>Type of change</th> <th>2005-2015</th> </tr> </thead> <tbody> <tr> <td>Semi-deciduous forest to cropland</td> <td>17,505.56</td> </tr> <tr> <td>Semi-deciduous forest to grassland</td> <td>2,435.56</td> </tr> <tr> <td>Semi-deciduous forest to other lands</td> <td>0.00</td> </tr> <tr> <td>Evergreen forest to cropland</td> <td>4,566.67</td> </tr> <tr> <td>Evergreen forest to grassland</td> <td>152.22</td> </tr> <tr> <td>Evergreen forest to other lands</td> <td>152.22</td> </tr> <tr> <td>Mangrove forest to cropland</td> <td>0.00</td> </tr> <tr> <td>Mangrove forest to grassland</td> <td>152.22</td> </tr> <tr> <td>Mangrove forest to other lands</td> <td>304.44</td> </tr> </tbody> </table>	Type of change	2005-2015	Semi-deciduous forest to cropland	17,505.56	Semi-deciduous forest to grassland	2,435.56	Semi-deciduous forest to other lands	0.00	Evergreen forest to cropland	4,566.67	Evergreen forest to grassland	152.22	Evergreen forest to other lands	152.22	Mangrove forest to cropland	0.00	Mangrove forest to grassland	152.22	Mangrove forest to other lands	304.44		
Type of change	2005-2015																						
Semi-deciduous forest to cropland	17,505.56																						
Semi-deciduous forest to grassland	2,435.56																						
Semi-deciduous forest to other lands	0.00																						
Evergreen forest to cropland	4,566.67																						
Evergreen forest to grassland	152.22																						
Evergreen forest to other lands	152.22																						
Mangrove forest to cropland	0.00																						
Mangrove forest to grassland	152.22																						
Mangrove forest to other lands	304.44																						
<b>QA/QC procedures applied:</b>	<p>Quality Control consisted in having a team of 5 technicians with experience in forests and remote sensing, all trained together by an MRV specialist. The team worked in the same office, and discussed any classification issues with each other.</p> <p>Quality Assurance was conducted using the SAIKU extension of Collect Earth. This tool allows the detection of whether:</p> <ul style="list-style-type: none"> <li>i) Data point was not filled</li> <li>ii) The class assigned followed the classification hierarchy, based on the % of individual element cover</li> <li>iii) Year of the Old image/Change image was less than the current image</li> <li>iv) Change classes are consistent with previous and current classes</li> <li>v) Open and closed forest was correctly classified, based on the 30% (open) and 65% (closed) cover threshold</li> </ul> <p>In the case of any error being detected, the ID of the data point was registered and the user performed the necessary corrections.</p>																						
<b>Uncertainty associated with this parameter:</b>	<table border="1"> <thead> <tr> <th>Category change</th> <th>Uncertainty estimate (confidence interval at 95%)</th> </tr> </thead> <tbody> <tr> <td>Semi-deciduous forest to cropland</td> <td>17.92%</td> </tr> <tr> <td>Semi-deciduous forest to grassland</td> <td>48.88%</td> </tr> <tr> <td>Semi-deciduous forest to other lands</td> <td>-</td> </tr> <tr> <td>Evergreen forest to cropland</td> <td>35.61%</td> </tr> <tr> <td>Evergreen forest to grassland</td> <td>196.00%</td> </tr> <tr> <td>Evergreen forest to other lands</td> <td>196.00%</td> </tr> <tr> <td>Mangrove forest to cropland</td> <td>-</td> </tr> <tr> <td>Mangrove forest to grassland</td> <td>196.00%</td> </tr> <tr> <td>Mangrove forest to other lands</td> <td>138.57%</td> </tr> <tr> <td></td> <td></td> </tr> </tbody> </table>	Category change	Uncertainty estimate (confidence interval at 95%)	Semi-deciduous forest to cropland	17.92%	Semi-deciduous forest to grassland	48.88%	Semi-deciduous forest to other lands	-	Evergreen forest to cropland	35.61%	Evergreen forest to grassland	196.00%	Evergreen forest to other lands	196.00%	Mangrove forest to cropland	-	Mangrove forest to grassland	196.00%	Mangrove forest to other lands	138.57%		
Category change	Uncertainty estimate (confidence interval at 95%)																						
Semi-deciduous forest to cropland	17.92%																						
Semi-deciduous forest to grassland	48.88%																						
Semi-deciduous forest to other lands	-																						
Evergreen forest to cropland	35.61%																						
Evergreen forest to grassland	196.00%																						
Evergreen forest to other lands	196.00%																						
Mangrove forest to cropland	-																						
Mangrove forest to grassland	196.00%																						
Mangrove forest to other lands	138.57%																						
<b>Any comment:</b>																							

## Emission factors

<b>Parameter:</b>	AGB <sub>before,j</sub>
<b>Description:</b>	Aboveground biomass of forest type <i>j</i> before conversion,
<b>Data unit:</b>	tons of dry matter per ha
<b>Source of data or description of the method for developing the data including the spatial level of the data (local, regional, national, international):</b>	<p>The data used for the present document are Tier 2 (country specific data or country level estimates or locally derived estimates) and they were sourced from the NFI (for deciduous and evergreen forests) or for Mangrove forests.</p> <p>For semi-deciduous and evergreen forest, data are from the Zambézia Forest Inventory. It includes data that was collected in Zambézia province during the NFI, in 2017 and 2018. Although the inventory covers the whole province of Zambézia this is still representative of the forests located in the ZILMP as forests across the province are homogenous (floristic and structural composition). Moreover, the higher sample size of the inventory covering the whole province will enable more precise estimates for emission factors.</p> <p><i>i. Sampling design</i></p> <p>Carbon stocks before conversion for deciduous and evergreen forests were estimated using data from the National Forest Inventory sample units that were located in Zambézia province. The sample units for surveying carbon stocks were allocated using restricted stratified random sampling, using 4 * 4 km systematic grid superimposed on the agro-ecological zoning map, and stratified among the 12 forest types. Was considered as the strata, the semi-deciduous forest “open and closed”, Miombo forest “open and closed”, semi-evergreen forest “open and closed”, semi-evergreen MoUntain forest “open and closed”, Mopane forest “open and closed”, and Mecrusse forest “open and closed”, of which only the first eight types occur in Zambézia province.</p> <p>The total number of sample units was determined using the optimal allocation (assuming a maximum error of 10% for the total volume, and 5% of confidence level). Proportional allocation was used to determine the number of sample units per stratum (Husch, Beers, and Kershaw 2003). For Zambézia province, 128 clusters (512 plots) were distributed between the eight (8) forest types. The cluster was used as a sampling unit, and each cluster has 4 plots of 0.1 ha (20 * 50 m), where each plot was divided into 4 sub-plots of 0.025 ha (10 * 25 m) (Annex-Figure 4).</p>

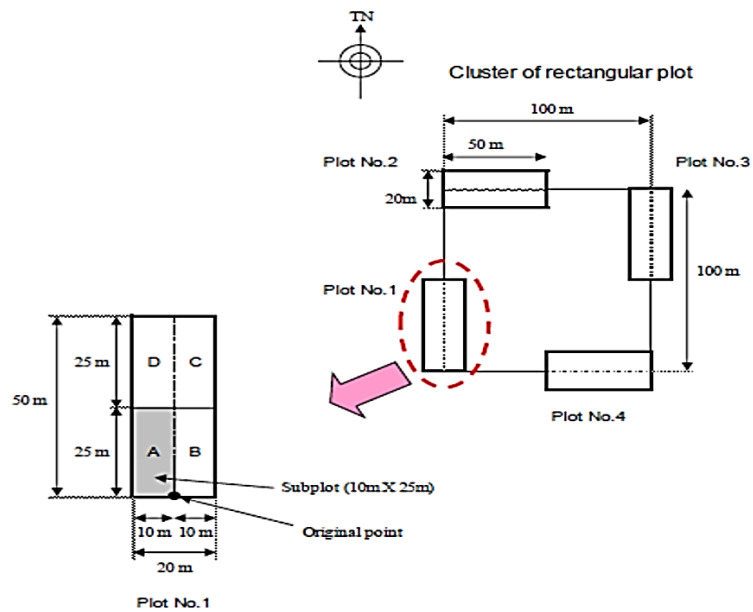

Annex-Figure 4: Design of each cluster used in the National Forest Inventory.

For estimating emission factors, the eight strata were aggregated into 2, and the similarity of the strata was used for the aggregation. The aggregation was done with the purpose of harmonizing the forest strata of the activity data with the emission factor data. Below the aggregation table.

Allocation stratum	EF Strata for MR
semi-deciduous open forest	semi-deciduous forest
semi-deciduous closed forest	
miombo open forest	
miombo closed forest	
semi-evergreen MoUtain open forest	semi-evergreen forest
semi-evergreen MoUtain closed forest	
semi-evergreen open forest	
semi-evergreen closed forest	

**ii. Data collection**

The plots were used for data collection of adult trees (dbh≥10cm), and the subplots "A" were used for data collection of established regeneration trees (10cm > dbh ≥ 5 cm), which were included in the calculation of the carbon stocks. Data collected in the plots and subplots included tree information (dbh, scientific name, total and commercial height, stem quality), soil, forest type (this information was used to validate the information from agro-ecological zoning map), and other important information. Tree data were used to estimate above ground biomass (AGB) and below ground biomass (BGB).

The NFI did not cover Mangrove forests, so, data from the literature was used. For other strata, data from literature were also used.

Details of data collection can be found at <https://www.fnfs.gov.mz/mrv/index.php/documentos/guioes/35-directrizes-do-inventario-florestal-nacional/file>.

**iii. Prediction at plot level**

Above ground biomass (AGB) and below ground biomass (BGB) were estimated using a series of allometric equations adjusted for ecosystems or tree species similar to those in the Zambézia province (Annex-Table 8), and this equation was applied at tree level.

The use of the equations meant, applying allometric equations of the specific species (*Millettia stuhlmannii* taub., *Pterocarpus angolensis* DC., *Afzelia quanzensis* Welw.) in all trees of these species to estimate AGB, regardless of forest types; The allometric equation of the semi-deciduous forest was applied for all trees of this forest type (except the species mentioned above), as well as in all trees of the species *Brachystegia spiciformis* Benth., and *Julbernardia globiflora* (Benth.) Troupin to estimate AGB and BGB, because they were the main species used to adjust this equation in this forest type. The equations of the semi-evergreen forest were applied in all remaining trees of this forest type to estimate AGB; and apply the semi-deciduous forest equation in all trees to estimate the BGB in this forest type (including species mentioned above in other forest type), and apply factor 0.275 (shoot:ratio) to estimate the BGB of the semi-evergreen forest.

Annex-Table 8: List of allometric equations used to estimate above and below biomass.

Stratum	Forest type or species	Above-ground biomass (AGB) [kg]	Below-ground biomass (BGB) [kg]
Semi-deciduous forest	Semi-deciduous forest (open and closed)	$\hat{Y} = 0.0763 * DAP^{2.2046} * H^{0.4918}$	$\hat{Y} = 0.1766 * DAP^{1.7844} * H^{0.3434}$
		Author: Mugasha <i>et al.</i> (2013)	Author: Mugasha <i>et al.</i> (2013)
	<i>Millettia stuhlmannii</i> taub.	$\hat{Y} = 5.7332 * DAP^{1.4567}$	$\hat{Y} = 0.1766 * DAP^{1.7844} * H^{0.3434}$
		Author: Mate <i>et al.</i> (2014)	Author: Mugasha <i>et al.</i> (2013)
	<i>Pterocarpus angolensis</i> DC.	$\hat{Y} = 0.2201 * DAP^{2.1574}$	$\hat{Y} = 0.1766 * DAP^{1.7844} * H^{0.3434}$
		Author: Mate <i>et al.</i> (2014)	Author: Mugasha <i>et al.</i> (2013)
<i>Afzelia quanzensis</i> Welw.	$\hat{Y} = 3.1256 * DAP^{1.5833}$	$\hat{Y} = 0.1766 * DAP^{1.7844} * H^{0.3434}$	
	Author: Mate <i>et al.</i> (2014)	Author: Mugasha <i>et al.</i> (2013)	
Evergreen forest	Evergreen forest (open and closed)	$\hat{Y} = \exp(-2.289 + 2.649 \ln(DAP) - 0.021(\ln(DAP))^2)$	$\hat{Y} = AGB * R/S; \quad R/S = 0.275$
		Author: IPCC (2003)	Author: Mokany <i>et al.</i> (2006)
		$\hat{Y} = 0.0613 * DAP^{2.7133}$	$\hat{Y} = AGB * R/S; \quad R/S = 0.275$

	Evergreen MoUntain forest (open and closed)	Author: Lisboa <i>et al.</i> (2018)	Author: Mokany <i>et al.</i> (2006)							
	<i>Millettia stuhlmannii</i> taub.	$\hat{Y} = 5.7332 * DAP^{1.4567}$	$\hat{Y} = 0.1766 * DAP^{1.7844} * H^{0.3434}$							
		Author: Mate <i>et al.</i> (2014)	Author: Mugasha <i>et al.</i> (2013)							
	<i>Pterocarpus angolensis</i> DC.	$\hat{Y} = 0.2201 * DAP^{2.1574}$	$\hat{Y} = 0.1766 * DAP^{1.7844} * H^{0.3434}$							
		Author: Mate <i>et al.</i> (2014)	Author: Mugasha <i>et al.</i> (2013)							
	<i>Afzelia quanzensis</i> Welw.	$\hat{Y} = 3.1256 * DAP^{1.5833}$	$\hat{Y} = 0.1766 * DAP^{1.7844} * H^{0.3434}$							
		Author: Mate <i>et al.</i> (2014)	Author: Mugasha <i>et al.</i> (2013)							
	<p><b>iv. Estimation</b></p> <p>The estimation of mean and their respective uncertainties (standard error, sampling error, and confidence interval) for the variables biomass, carbon and carbon dioxide equivalent (above and below ground) for the two strata (semi-deciduous forest and semi-evergreen forest), were done using the forest inventory data analysis approach proposed by Bechtold &amp; Patterson (2005) chapter 4 of the book “The Enhanced Forest Inventory and Analysis Program-National Sampling Design and Estimation Procedures”. Details of this methodology are described in Zambézia inventory report, available at <a href="https://fnds.gov.mz/mrv/index.php/documentos/relatorios/41-relatorio-de-inventario-florestal-da-zambezia-actualizado/file">https://fnds.gov.mz/mrv/index.php/documentos/relatorios/41-relatorio-de-inventario-florestal-da-zambezia-actualizado/file</a>. For mangrove forests, data are secondary, extracted from existing literature. Stringer <i>et al.</i> (2015)<sup>28</sup> made an inventory on this ecosystem in the Zambezi delta in Mozambique; we can easily assume that carbon stocks are comparable to those of mangroves in Zambézia province. They divided mangroves into 5 strata and estimated carbon stocks in above and belowground biomass. Since we do not have information on these specific strata for ZILMP, the mean and standard error of biomass (AGB and BGB) of mangrove forest, comes indirectly from table 1 of the article by Stringer <i>et al.</i> (2015). For its determination, first the mean of carbon was found for the two pools (sum of overstory and understory carbon) for each stratum (Height Class 1, ..., Height Class 5), followed by the calculation of the mean of the ecosystem (mean weighted according to the stratum areas). Finally, the carbon was converted to biomass using the conversion factor of 0.47 proposed in the IPCC good practice guide.</p> <p>Spatial level: Regional</p> <p>Spatial level: Regional</p>									
	<b>Value applied:</b>	<table border="1"> <tr> <td>Semi-deciduous forest (FSD)</td> <td>144.69</td> </tr> <tr> <td>Evergreen forest (FSSV)</td> <td>123.13</td> </tr> <tr> <td>Mangrove forest (FF)</td> <td>269.01</td> </tr> </table>			Semi-deciduous forest (FSD)	144.69	Evergreen forest (FSSV)	123.13	Mangrove forest (FF)	269.01
	Semi-deciduous forest (FSD)	144.69								
Evergreen forest (FSSV)	123.13									
Mangrove forest (FF)	269.01									

<sup>28</sup> Stringer, C. E.; Trettin, C. C.; Zarnoch, S. J. and Tang, W. 2015. Carbon stocks of mangroves within the Zambezi River Delta, Mozambique. *Forest Ecology Management* 354:139–148.

	The values above are estimated and extracted in the " <a href="#">Emission factor v.2</a> " workbook, and then they are recorded in the cells "B4", "B10" and "B16" respectively, of the "BIOMASS" worksheet tab in the " <a href="#">Outside ZILMP Emissions Calculations RL (2005 2015) 28 10 20</a> " workbook. These values are then applied in the range "C9:C26" of the "Reference Level" worksheet tab in the " <a href="#">Outside ZILMP Emissions Calculations RL (2005 2015) 28 10 20</a> " workbook for estimating emissions.								
<b>QA/QC procedures applied</b>	The QA/QC procedures consisted on the following: <ul style="list-style-type: none"> <li>• SOPs were developed.</li> <li>• A training on the SOPs was conducted prior to the field work. This training lasted for 3 weeks, and consisted of training on the usage of all equipment and evaluating the specific skills of each participant, in order to determine the team and brigade leaders. On the start of the 2<sup>nd</sup> phase of the IFN (2017) an additional 1-week training was conducted, to refresh the participants and train any new members.</li> <li>• The supervisor of each inventory team conducted a remeasurement of 4 trees per plot which means 16 trees per cluster. This served to ensure that the SOPs were adequately implemented.</li> <li>• An independent measurement of 10% of the plots. This activity was conducted by technicians of the National Directorate of Forests, who had participated in the Provincial Inventories of Gaza and Cabo Delgado. Diameter below 10%.</li> <li>• The adequacy of the allometric models, including root-to-shoot ratios used was confirmed by experts of the Faculty of Agronomy and Forest Engineering (FAEF) and the Department of Biology Sciences (DCB) of the Eduardo Mondlane University (UEM).</li> <li>• The World Bank conducted two regular supervision missions of the National Forest Inventories to confirm the adequate implementation of the SOPs and suggest areas for improvement. The report can be found <a href="#">here</a>.</li> <li>• An independent expert (Jim Alegria, ex-US Forestry Service) was hired in order to evaluate the methodology for the inventory and support in the estimation step. The report can be found <a href="#">here</a>.</li> </ul>								
<b>Uncertainty associated with this parameter:</b>	<table border="1"> <thead> <tr> <th>Forest type</th> <th>Uncertainty estimate (confidence interval at 95%)</th> </tr> </thead> <tbody> <tr> <td>FSD</td> <td>19.72%</td> </tr> <tr> <td>FSSV</td> <td>18.33%</td> </tr> <tr> <td>FF</td> <td>8.00%</td> </tr> </tbody> </table>	Forest type	Uncertainty estimate (confidence interval at 95%)	FSD	19.72%	FSSV	18.33%	FF	8.00%
Forest type	Uncertainty estimate (confidence interval at 95%)								
FSD	19.72%								
FSSV	18.33%								
FF	8.00%								
<b>Any comment:</b>	-								

<b>Parameter:</b>	BGB <sub>before,j</sub>
<b>Description:</b>	Belowground biomass of forest type <i>j</i> before conversion,
<b>Data unit:</b>	tons of dry matter per ha
<b>Source of data or description of the method for developing the data including the spatial level of the data (local, regional,</b>	<p>For semi-deciduous and evergreen forest, data are from the Zambézia Forest Inventory. It includes data that was collected in Zambézia province during the NFI, in 2017 and 2018. Please refer to parameter AGB<sub>before,j</sub> for more information.</p> <p>For mangrove forests, please refer to parameter AGB<sub>before,j</sub> for more information.</p> <p>Spatial level: Regional</p>

<b>national, international):</b>									
<b>Value applied:</b>	<table border="1"> <tr> <td>Semi-deciduous forest (FSD)</td> <td>49.95</td> </tr> <tr> <td>Evergreen forest (FSSV)</td> <td>42.06</td> </tr> <tr> <td>Mangrove forest (FF)</td> <td>85.43</td> </tr> </table> <p>The values above are estimated and extracted in the workbook "<a href="#">Emission factor v.2</a>" and then they are recorded in the cells "B45", "B51" and "B57" respectively, of the "BIOMASS" worksheet tab in the "<a href="#">Outside ZILMP Emissions Calculations RL (2005 2015) 28 10 20</a>" workbook. These values are then applied in the range "E9:E26" of the "Reference Level" worksheet tab in the "<a href="#">Outside ZILMP Emissions Calculations RL (2005 2015) 28 10 20</a>" workbook for estimating emissions.</p>	Semi-deciduous forest (FSD)	49.95	Evergreen forest (FSSV)	42.06	Mangrove forest (FF)	85.43		
Semi-deciduous forest (FSD)	49.95								
Evergreen forest (FSSV)	42.06								
Mangrove forest (FF)	85.43								
<b>QA/QC procedures applied</b>	Please see section QA/QC procedures under parameter $AGB_{before,j}$ .								
<b>Uncertainty associated with this parameter:</b>	<table border="1"> <thead> <tr> <th>Forest type</th> <th>Uncertainty estimate (confidence interval at 95%)</th> </tr> </thead> <tbody> <tr> <td>FSD</td> <td>16.58%</td> </tr> <tr> <td>FSSV</td> <td>16.71%</td> </tr> <tr> <td>FF</td> <td>10.00%</td> </tr> </tbody> </table>	Forest type	Uncertainty estimate (confidence interval at 95%)	FSD	16.58%	FSSV	16.71%	FF	10.00%
Forest type	Uncertainty estimate (confidence interval at 95%)								
FSD	16.58%								
FSSV	16.71%								
FF	10.00%								
<b>Any comment:</b>									

<b>Parameter:</b>	$AGB_{after,i}$						
<b>Description:</b>	Aboveground biomass of non-forest type $i$ after conversion						
<b>Data unit:</b>	tons of dry matter per ha						
<b>Source of data or description of the method for developing the data including the spatial level of the data (local, regional, national, international):</b>	<p>For cropland: The values and assumptions of 2006 IPCC GL, Volume 4, Chapter 5 are used because, unfortunately, there aren't country-specific data. The agricultural land in Mozambique is mostly under the annual-crop farming practices that drive conversion of forest land to agricultural lands. So, according to 2006 IPCC GL (Volume 4, Chapter 5, Section 5.28), for lands planted in annual crops, the default value of growth in crops planted after conversion is 5 tonnes of C per hectare, based on the original IPCC Guidelines recommendation of 10 tonnes of dry biomass per hectare (dry biomass has been converted to tonnes carbon in Table 5.9) (2006 IPCC, Volume 4, Chapter 5, Section 5.28).</p> <p>For grassland: The values and assumptions of 2006 IPCC GL, Volume 4, Chapter 6 are used because, unfortunately, there aren't country-specific data. As the climate in most of Mozambique is tropical dry to subtropical dry, the value of peak-above ground biomass for tropical dry of TABLE 6.4 is assumed.</p> <p>For other lands: No default values exist for these conversions.</p> <p>Spatial level: International</p>						
<b>Value applied:</b>	<table border="1"> <tr> <td>Cropland (C)</td> <td>10</td> </tr> <tr> <td>Grassland (P)</td> <td>2.3</td> </tr> <tr> <td>Other lands (A O U)</td> <td>0.0</td> </tr> </table> <p>The values above are recorded in the ranges "B5:B9", "B11:B15" and "B17:B21" of the "BIOMASS" worksheet tab in the "<a href="#">Outside ZILMP Emissions Calculations RL (2005 2015) 28 10 20</a>" workbook. These values</p>	Cropland (C)	10	Grassland (P)	2.3	Other lands (A O U)	0.0
Cropland (C)	10						
Grassland (P)	2.3						
Other lands (A O U)	0.0						

	are then applied in the range "D9:D26" of the "Reference Level" worksheet tab in the " <a href="#">Outside ZILMP Emissions Calculations RL (2005 2015) 28 10 20</a> " workbook for estimating emissions.								
<b>QA/QC procedures applied</b>	The adequacy in the use of these default values was confirmed with the experts in GHG Inventory in DINAB.								
<b>Uncertainty associated with this parameter:</b>	<table border="1"> <thead> <tr> <th>Non-forest type</th> <th>Uncertainty estimate (Confidence interval at 95%)</th> </tr> </thead> <tbody> <tr> <td>Cropland (C)</td> <td>75.00%</td> </tr> <tr> <td>Grassland (P)</td> <td>75.00%</td> </tr> <tr> <td>Other lands (A O U)</td> <td>-</td> </tr> </tbody> </table>	Non-forest type	Uncertainty estimate (Confidence interval at 95%)	Cropland (C)	75.00%	Grassland (P)	75.00%	Other lands (A O U)	-
Non-forest type	Uncertainty estimate (Confidence interval at 95%)								
Cropland (C)	75.00%								
Grassland (P)	75.00%								
Other lands (A O U)	-								
<b>Any comment:</b>									

<b>Parameter:</b>	BGB <sub>after,i</sub>						
<b>Description:</b>	Belowground biomass of non-forest type <i>i</i> after conversion						
<b>Data unit:</b>	tons of dry matter per ha						
<b>Source of data or description of the method for developing the data including the spatial level of the data (local, regional, national, international):</b>	<p>For cropland: The values and assumptions of 2006 IPCC GL, Volume 4, Chapter 5 are used. Tier 2 may modify the assumption that carbon stocks immediately following conversion are zero. In this case, it is assumed that conversion leads to annual croplands and in the case the carbon stock in biomass after one year for annual crops provided in TABLE 5.9 is used.</p> <p>For grassland: The values and assumptions of 2006 IPCC GL, Volume 4, Chapter 6, TABLE 6.1 and TABLE 6.4 are used because, unfortunately, there aren't country-specific data. As the climate in most of Mozambique is tropical dry to subtropical dry, the value for semi-arid grassland in tropical dry climate zone is used, therefore a root-shoot ratio of 2.8 (TABLE 6.1) is applied to the value of peak above-ground biomass, 2.3 tonnes of dry biomass per hectare (TABLE 6.4), generating the expected values 6.4 tonnes of dry biomass per hectare.</p> <p>For other lands: No default values exist for these conversions.</p> <p>Spatial level: International</p>						
<b>Value applied:</b>	<table border="1"> <tbody> <tr> <td>Cropland (C)</td> <td>0.00</td> </tr> <tr> <td>Grassland (P)</td> <td>6.44</td> </tr> <tr> <td>Other lands (A O U)</td> <td>0.00</td> </tr> </tbody> </table> <p>The values above are recorded in the ranges "B46:E50", "B52:B56" and "B58:B62" of the "BIOMASS" worksheet tab in the "<a href="#">Outside ZILMP Emissions Calculations RL (2005 2015) 28 10 20</a>" workbook. These values are then applied in the range "F9:F26" of the "Reference Level" worksheet tab in the "<a href="#">Outside ZILMP Emissions Calculations RL (2005 2015) 28 10 20</a>" workbook for estimating emissions.</p>	Cropland (C)	0.00	Grassland (P)	6.44	Other lands (A O U)	0.00
Cropland (C)	0.00						
Grassland (P)	6.44						
Other lands (A O U)	0.00						
<b>QA/QC procedures applied</b>	The adequacy in the use of these default values was confirmed with the experts in GHG Inventory in DINAB.						



<b>Uncertainty associated with this parameter:</b>	<b>Non-forest type</b>	<b>Uncertainty estimate (Confidence interval at 95%)</b>
	Cropland (C)	-
	Grassland (P)	121.04%
	Other lands (A O U)	-
<b>Any comment:</b>		

### 1.1.2.1.1.3 Calculation of the average annual historical emissions over the Reference Period

The following table shows the average annual historical emissions results obtained per category changes from a forest type to a non-forest type over the Reference Period. The emissions are generated relating the data and parameters described above (Activity data and Emission Factors) and summarized in the Annex-Table 9, by applying Equation 17.

Annex-Table 9: Calculation of the average annual historical emissions over the Reference Period.

Category changes	Average annual historical activity data <sub>j,i</sub> (ha/yr)	AGB <sub>before,j</sub> (tdm/ha)	BGB <sub>before,j</sub> (tdm/ha)	AGB <sub>after,i</sub> (tdm/ha)	BGB <sub>after,i</sub> (tdm/ha)	Average annual historical emissions (tCO <sub>2e</sub> /yr)
Semi-deciduous forest to cropland	17,505.56	144.69	49.4995	10.00	0.00	5,570,060.47
Semi-deciduous forest to grassland	2,435.56	144.69	49.4995	2.30	6.44	780,253.50
Semi-deciduous forest to other lands	0.00	144.69	49.4995	0.00	0.00	0.00
Evergreen forest to cropland	4,566.67	123.13	42.0626	10.00	0.00	1,221,308.32
Evergreen forest to grassland	152.22	123.13	42.066	2.30	6.44	41,040.81
Evergreen forest to other lands	152.22	123.13	42.0626	0.00	0.00	43,333.57
Mangrove to cropland	0.00	269.01	85.43	0.00	0.00	0.00
Mangrove to grassland	152.22	269.01	85.43	2.30	6.44	90,687.38
Mangrove to other lands	304.44	269.01	85.43	0.00	0.00	185,960.28
<b>Total</b>						<b>7,932,644.34</b>

## 5.2.4 Estimated Reference Level

### *ER Program Reference level*

Crediting Period year <i>t</i>	Average annual historical emissions from deforestation over the Reference Period (tCO <sub>2-e</sub> /yr)	If applicable, average annual historical emissions from forest degradation over the Reference Period (tCO <sub>2-e</sub> /yr)	If applicable, average annual historical removals by sinks over the Reference Period (tCO <sub>2-e</sub> /yr)	Adjustment, if applicable (tCO <sub>2-e</sub> /yr)	Reference level (tCO <sub>2-e</sub> /yr)
2018	7,932,644.34	-	-	-	7,932,644.34
2019	7,932,644.34	-	-	-	7,932,644.34
2020	7,932,644.34	-	-	-	7,932,644.34
2021	7,932,644.34	-	-	-	7,932,644.34
2022	7,932,644.34	-	-	-	7,932,644.34
2023	7,932,644.34	-	-	-	7,932,644.34
2024	7,932,644.34	-	-	-	7,932,644.34

## 5.3 MONITORING AND REPORTING PERIOD

The monitoring and reporting period covers emissions in 2019 and 2020 outside of ZILMP program.

### 5.3.1 Measurement, monitoring and reporting approach

#### 1.1.3 Line Diagram

The Annex-Figure 5 illustrates the emissions reductions calculation workflow during the Monitoring Period.

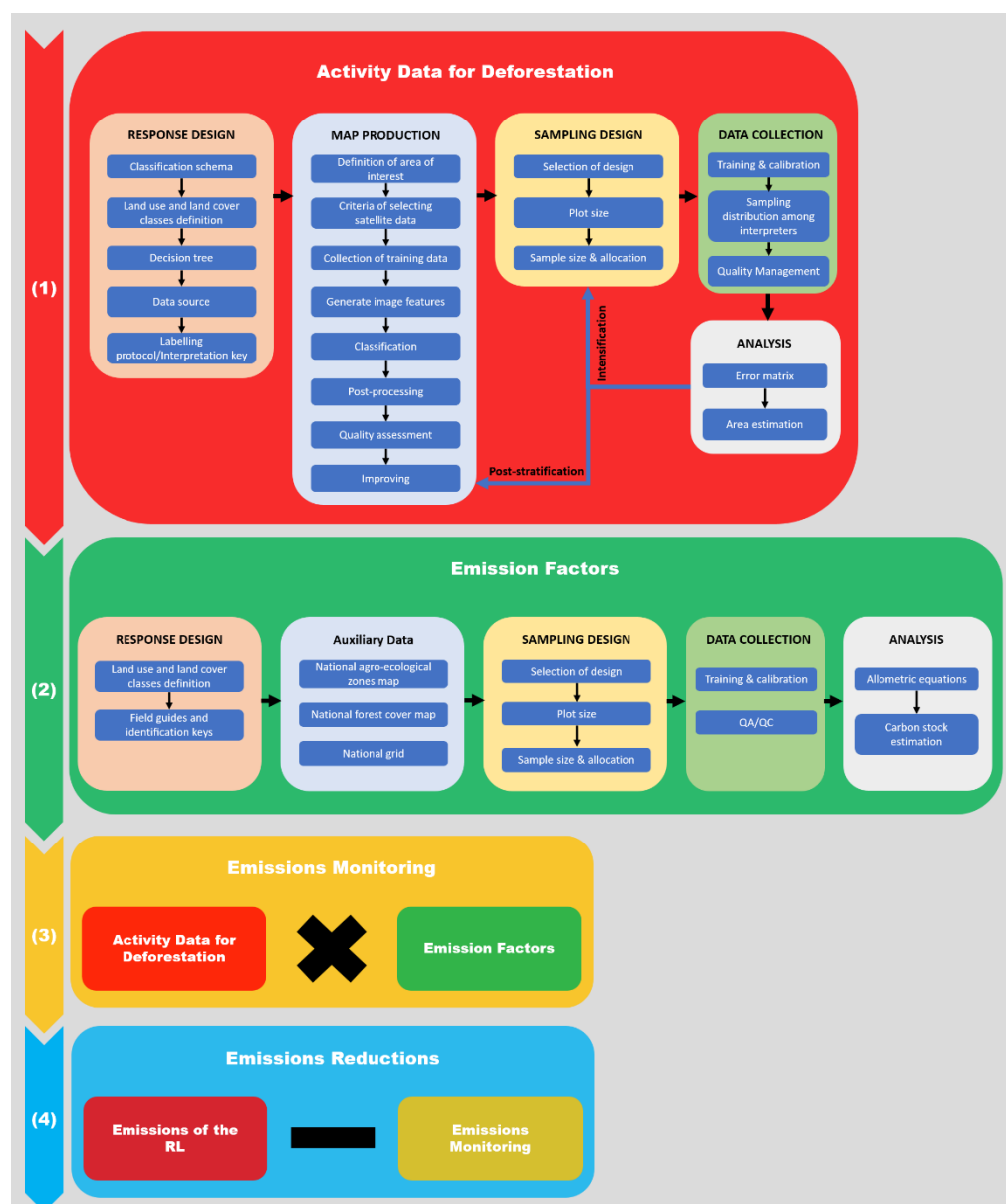

Annex-Figure 5: Emissions reductions calculation workflow.

#### 1.1.4 Calculation

$$ER_{ERP,t} = RL_t - GHG_t \quad \text{Equation 21}$$

Where:

$ER_{ERP}$	=	Emission Reductions under the area outside the scope of ZILMP in year $t$ ; $tCO_2e*year^{-1}$ .
$RL_{RP}$	=	Gross emissions of the RL from deforestation over the Reference Period; $tCO_2e*year^{-1}$ .
$GHG_t$	=	Monitored gross emissions from deforestation at year $t$ ; $tCO_2e*year^{-1}$ ;
$T$	=	Number of years during the monitoring period; <i>dimensionless</i> .

### Reference Level ( $RL_t$ )

Gross emissions of the RL from deforestation over the Reference Period ( $RL_{RP}$ ) are estimated as the sum of annual change in total biomass carbon stocks ( $\Delta C_{B_t}$ ) during the reference period.

$$RL_{RP} = \frac{\sum_t^{RP} \Delta C_{B_t}}{RP} \quad \text{Equation 22}$$

Where:

$\Delta C_{B_t}$	=	Annual change in total biomass carbon stocks at year $t$ ; $tC*year^{-1}$ ;
$RP$	=	Reference period; <i>years</i> .

Following the 2006 IPCC Guidelines, the annual change in total biomass carbon stocks forest land converted to other land-use category ( $\Delta C_{B_t}$ ) would be estimated through the following equation:

$$\Delta C_{B_t} = \Delta C_G + \Delta C_{CONVERSION} - \Delta C_L \quad \text{Equation 23}$$

Where:

$\Delta C_{B_t}$	Annual change of total biomass carbon stocks during the period, in tC per year;
$\Delta C_G$	Annual increase in carbon stocks in biomass due to growth on land converted to another land-use category, in tC per hectare and year;
$\Delta C_{CONVERSION}$	Initial change in carbon stocks in biomass on land converted to other land-use category, in tC per hectare and year; and
$\Delta C_L$	Annual decrease in biomass carbon stocks due to losses from harvesting, fuel wood gathering and disturbances on land converted to other land-use category, in tC per hectare and year.

Following the recommendations set in chapter 2.2.1 of the GFOI Methods Guidance Document for applying IPCC Guidelines and guidance in the context of REDD+<sup>29</sup>, the above equation will be simplified and it will be assumed that:

- The annual change in total biomass carbon stocks ( $\Delta C_B$ ) is equal to the initial change in carbon stocks ( $\Delta C_{CONVERSION}$ );

Considering equation 2.16 of the 2006 IPCC GL for estimating ( $\Delta C_{CONVERSION}$ ) the change of biomass carbon stocks could be expressed with the following equation:

$$\Delta C_{B_t} = \sum_{j,i} (B_{Before,j} - B_{After,i}) \times CF \times \frac{44}{12} \times A(j,i)_{RP} \quad \text{Equation 24}$$

<sup>29</sup> [https://www.reddcompass.org/documents/184/0/MGD2.0\\_English/c2061b53-79c0-4606-859f-cfc6c8cc6a83](https://www.reddcompass.org/documents/184/0/MGD2.0_English/c2061b53-79c0-4606-859f-cfc6c8cc6a83)

Where:

$A(j, i)_{RP}$  Area converted/transited from forest type  $j$  to non-forest type  $i$  during the Reference Period, in hectares per year. In this case, three forest land conversions are possible:

- (Semi-)deciduous forest to Non-forest type  $i$ ;
- (Semi-)evergreen forest to Non-forest type  $i$ ; and
- Mangrove forest to Non-forest type  $i$ .

Five types of non-forest land are considered:

- Cropland (C);
- Grassland (P);
- Wetland (A);
- Settlement (U); and
- Other lands (O).

$B_{Before,j}$  Total biomass of forest type  $j$  before conversion/transition, in tons of dry matter per ha. This is equal to the sum of aboveground ( $AGB_{Before,j}$ ) and belowground biomass ( $BGB_{Before,j}$ ) and it is defined for each forest type.

$B_{After,i}$  Total biomass of non-forest type  $i$  after conversion, in tons dry matter per ha. This is equal to the sum of aboveground ( $AGB_{After,i}$ ) and belowground biomass ( $BGB_{After,i}$ ) and it is defined for each of the five non-forest IPCC Land Use categories.

$CF$  Carbon fraction of dry matter in tC per ton dry matter. The value used is:

- **0.47** is the default for (sub)tropical forest as per IPCC AFOLU guidelines 2006, Table 4.3.

44/12 Conversion of C to CO<sub>2</sub>

### Monitored emissions ( $GHG_t$ )

Annual gross GHG emissions over the monitoring period in the Accounting Area ( $GHG_t$ ) are estimated as the sum of annual change in total biomass carbon stocks ( $\Delta C_{B_t}$ ).

$$GHG_t = \frac{\sum_t^T \Delta C_{B_t}}{T} \quad \text{Equation 25}$$

Where:

$\Delta C_{B_t}$  = Annual change in total biomass carbon stocks at year  $t$ ;  $tC \cdot year^{-1}$

$T$  = Number of years during the monitoring period; *dimensionless*.

### Changes in total biomass carbon stocks

Following the 2006 IPCC Guidelines, the annual change in total biomass carbon stocks forest land converted to other land-use category ( $\Delta C_B$ ) would be estimated through **Equation 23**. Making the same assumptions as described above for the RL the change of biomass carbon stocks could be expressed with the following equation:

$$\Delta C_B = \sum_{j,i} (B_{Before,j} - B_{After,i}) \times CF \times \frac{44}{12} \times A(j, i)_{MP} \quad \text{Equation 26}$$

Where:

$A(j, i)_{MP}$  Area converted/transited from forest type  $j$  to non-forest type  $i$  during the Monitoring Period, in hectare per year. In this case, three forest land conversions are possible:

- (Semi-)deciduous forest to Non-forest type  $i$ ;
- (Semi-)evergreen forest to Non-forest type  $i$ ; and

- Mangrove forest to Non-forest type  $i$ .

Five types of non-forest land are considered:

- Cropland (C);
- Grassland (P);
- Wetland (A);
- Settlement (U); and
- Other lands (O).

$B_{Before,j}$  Total biomass of forest type  $j$  before conversion/transition, in tons of dry matter per ha. This is equal to the sum of aboveground ( $AGB_{Before,j}$ ) and belowground biomass ( $BGB_{Before,j}$ ) and it is defined for each forest type.

$B_{After,i}$  Total biomass of non-forest type  $i$  after conversion, in *tons dry matter per ha*. This is equal to the sum of aboveground ( $AGB_{After,i}$ ) and belowground biomass ( $BGB_{After,i}$ ) and it is defined for each of the five non-forest IPCC Land Use categories.

$CF$  Carbon fraction of dry matter in tC per ton dry matter. The value used is:

- **0.47** is the default for (sub)tropical forest as per IPCC AFOLU guidelines 2006, Table 4.3.

44/12 Conversion of C to CO<sub>2</sub>

## 5.3.2 Data and parameters

### 1.1.5 Fixed Data and Parameters

<b>Parameter:</b>	AGB <sub>before,j</sub>										
<b>Description:</b>	Aboveground biomass of forest type <i>j</i> before conversion,										
<b>Data unit:</b>	tons of dry matter per ha										
<b>Source of data or description of the method for developing the data including the spatial level of the data (local, regional, national, international):</b>	<p>The data used for the present document are Tier 2 (country specific data or country level estimates or locally derived estimates) and they were sourced from the NFI (for deciduous and evergreen forests) or for Mangrove forests.</p> <p>For semi-deciduous and evergreen forest, data are from the Zambézia Forest Inventory. It includes data that was collected in Zambézia province during the NFI, in 2017 and 2018. Although the inventory covers the whole province of Zambézia this is still representative of the forests located in the ZILMP as forests across the province are homogenous (floristic and structural composition). Moreover, the higher sample size of the inventory covering the whole province will enable more precise estimates for emission factors.</p> <p><i>i. Sampling design</i></p> <p>Carbon stocks before conversion for deciduous and evergreen forests were estimated using data from the National Forest Inventory sample units that were located in Zambézia province. The sample units for surveying carbon stocks were allocated using restricted stratified random sampling, using 4 * 4 km systematic grid superimposed on the agro-ecological zoning map, and stratified among the 12 forest types. Was considered as the strata, the semi-deciduous forest “open and closed”, Miombo forest “open and closed”, semi-evergreen forest “open and closed”, semi-evergreen MoUntain forest “open and closed”, Mopane forest “open and closed”, and Mecrusse forest “open and closed”, of which only the first eight types occur in Zambézia province.</p> <p>The total number of sample units was determined using the optimal allocation (assuming a maximum error of 10% for the total volume, and 5% of confidence level). Proportional allocation was used to determine the number of sample units per stratum (Husch, Beers, and Kershaw 2003). For Zambézia province, 128 clusters (512 plots) were distributed between the eight (8) forest types. The cluster was used as a sampling unit, and each cluster has 4 plots of 0.1 ha (20 * 50 m), where each plot was divided into 4 sub-plots of 0.025 ha (10 * 25 m) (Figure 6).</p> <p>For estimating emission factors, the eight strata were aggregated into 2, and the similarity of the strata was used for the aggregation. The aggregation was done with the purpose of harmonizing the forest strata of the activity data with the emission factor data. Below the aggregation table.</p> <table border="1" style="width: 100%; border-collapse: collapse;"> <thead> <tr> <th style="background-color: #d9ead3;">Allocation stratum</th> <th style="background-color: #d9ead3;">EF Strata for MR</th> </tr> </thead> <tbody> <tr> <td>semi-deciduous open forest</td> <td rowspan="4" style="text-align: center; vertical-align: middle;">semi-deciduous forest</td> </tr> <tr> <td>semi-deciduous closed forest</td> </tr> <tr> <td>miombo open forest</td> </tr> <tr> <td>miombo closed forest</td> </tr> <tr> <td>semi-evergreen MoUntain open forest</td> <td rowspan="2" style="text-align: center; vertical-align: middle;">semi-evergreen forest</td> </tr> <tr> <td>semi-evergreen MoUntain closed forest</td> </tr> </tbody> </table>	Allocation stratum	EF Strata for MR	semi-deciduous open forest	semi-deciduous forest	semi-deciduous closed forest	miombo open forest	miombo closed forest	semi-evergreen MoUntain open forest	semi-evergreen forest	semi-evergreen MoUntain closed forest
Allocation stratum	EF Strata for MR										
semi-deciduous open forest	semi-deciduous forest										
semi-deciduous closed forest											
miombo open forest											
miombo closed forest											
semi-evergreen MoUntain open forest	semi-evergreen forest										
semi-evergreen MoUntain closed forest											



semi-evergreen open forest semi-evergreen closed forest
--

#### **ii. Data collection**

The plots were used for data collection of adult trees ( $dbh \geq 10\text{cm}$ ), and the subplots "A" were used for data collection of established regeneration trees ( $10\text{cm} > dbh \geq 5\text{ cm}$ ), which were included in the calculation of the carbon stocks. Data collected in the plots and subplots included tree information (dbh, scientific name, total and commercial height, stem quality), soil, forest type (this information was used to validate the information from agro-ecological zoning map), and other important information. Tree data were used to estimate above ground biomass (AGB) and below ground biomass (BGB).

The NFI did not cover Mangrove forests, so, data from the literature was used. For other strata, data from literature were also used.

Details of data collection can be find at <https://www.fnds.gov.mz/mrv/index.php/documentos/guioes/35-directrizes-do-inventario-florestal-nacional/file>.

#### **iii. Prediction at plot level**

Above ground biomass (AGB) and below ground biomass (BGB) were estimated using a series of allometric equations adjusted for ecosystems or tree species similar to those in the Zambézia province (Table 1), and this equation was applied at tree level.

The use of the equations meant, applying allometric equations of the specific species (*Millettia stuhlmannii* taub., *Pterocarpus angolensis* DC., *Azelia quanzensis* Welw.) in all trees of these species to estimate AGB, regardless of forest types. The allometric equation of the semi-deciduous forest was applied for all trees of this forest type (except the species species mentioned above), as well as in all trees of the species *Brachystegia spiciformis* Benth., and *Julbernardia globiflora* (Benth.) Troupin to estimate AGB and BGB, because they were the main species used to adjust this equation in this forest type. The equations of the semi-evergreen forest were applied in all remaining trees of this forest type to estimate AGB; and apply the semi-deciduous forest equation in all trees to estimate the BGB in this forest type (including species mentioned above in other forest type), and apply factor 0.28 (shoot ratio) to estimate the BGB of the semi-evergreen forest.

Since Mozambique was not able to propagate this source of error through Monte Carlo (MC) simulation we have increased the sampling uncertainty of AGB and BGB for forest strata by 10% at 90% confidence level using the quadrature approach and the combined error was propagated in the MC simulation.

#### **iv. Estimation**

The estimation of mean and their respective uncertainties (standard error, sampling error, and confidence interval) for the variables biomass, carbon and carbon dioxide equivalent (above and below ground) for the two strata (semi-deciduous forest and semi-evergreen forest), were done using the forest inventory data analysis approach proposed by Bechtold & Patterson (2005) chapter 4 of the book "The Enhanced Forest Inventory and Analysis Program-National Sampling Design and Estimation Procedures". Details of this methodology are described in Zambézia inventory report, available at <https://fnds.gov.mz/mrv/index.php/documentos/relatorios/41-relatorio-de-inventario->

	<p><a href="#">florestal-da-zambezia-actualizado/file</a>. For mangrove forests, data are secondary, extracted from existing literature. Stringer <i>et al.</i> (2015)<sup>30</sup> made an inventory on this ecosystem in the Zambezi delta in Mozambique; we can easily assume that carbon stocks are comparable to those of mangroves in Zambézia province. They divided mangroves into 5 strata and estimated carbon stocks in above and belowground biomass. Since we do not have information on these specific strata for ZILMP, the mean and standard error of biomass (AGB and BGB) of mangrove forest, comes indirectly from table 1 of the article by Stringer <i>et al.</i> (2015). For its determination, first the mean of carbon was found for the two pools (sum of overstory and understory carbon) for each stratum (Height Class 1, ..., Height Class 5), followed by the calculation of the mean of the ecosystem (mean weighted according to the stratum areas). Finally, the carbon was converted to biomass using the conversion factor of 0.47 proposed in the IPCC good practice guide.</p> <p>Spatial level: Regional</p>						
<p><b>Value applied:</b></p>	<table border="1" data-bbox="691 678 1155 781"> <tr> <td>Semi-deciduous forest (FSD)</td> <td>144.69</td> </tr> <tr> <td>Evergreen forest (FSSV)</td> <td>123.13</td> </tr> <tr> <td>Mangrove forest (FF)</td> <td>269.01</td> </tr> </table> <p>The values above are estimated and extracted in the "<a href="#">Emission factor v.2</a>" workbook, and then they are recorded in the cells "B4", "B10" and "B16" respectively, of the "BIOMASS" worksheet tab in the "<a href="#">Outside ZILMP Emissions Calculations MR (2019)</a>" and "<a href="#">Outside ZILMP Emissions Calculations MR (2020)</a>" workbooks. These values are then applied in the range "C9:C20" of the "EMISSION MONITORING PERIOD(EMP)" worksheet tab in the "<a href="#">Outside ZILMP Emissions Calculations MR (2019)</a>" and "<a href="#">Outside ZILMP Emissions Calculations MR (2020)</a>" workbooks for estimating emissions.</p>	Semi-deciduous forest (FSD)	144.69	Evergreen forest (FSSV)	123.13	Mangrove forest (FF)	269.01
Semi-deciduous forest (FSD)	144.69						
Evergreen forest (FSSV)	123.13						
Mangrove forest (FF)	269.01						
<p><b>QA/QC procedures applied</b></p>	<p>The QA/QC procedures consisted on the following:</p> <ul style="list-style-type: none"> <li>• SOPs were developed as described in <i>Section 2.1 - National Forest Inventory</i>.</li> <li>• A training on the SOPs was conducted prior to the field work. This training lasted for 3 weeks, and consisted of training on the usage of all equipment and evaluating the specific skills of each participant, in order to determine the team and brigade leaders. On the start of the 2<sup>nd</sup> phase of the IFN (2017) an additional 1-week training was conducted, to refresh the participants and train any new members.</li> <li>• The supervisor of each inventory team conducted a remeasurement of 4 trees per plot which means 16 trees per cluster. This served to ensure that the SOPs were adequately implemented.</li> <li>• An independent measurement of 10% of the plots. This activity was conducted by technicians of the National Directorate of Forests, who had participated in the Provincial Inventories of Gaza and Cabo Delgado. Diameter error must be below 10%.</li> <li>• The adequacy of the allometric models, including root-to-shoot ratios used was confirmed by experts of the Faculty of Agronomy and Forest Engineering (FAEF) and the Department of Biology Sciences (DCB) of the University Eduardo Mondlane (UEM).</li> <li>• The World Bank conducted two regular supervision missions of the National Forest Inventories to confirm the adequate implementation of the SOPs and suggest areas for improvement. The report can be found <a href="#">here</a>.</li> <li>• An independent expert (Jim Alegria, ex-US Forestry Service) was hired in order to evaluate the methodology for the inventory and support in the estimation step. The report can be found <a href="#">here</a>.</li> </ul>						

<sup>30</sup> Stringer, C. E.; Trettin, C. C.; Zarnoch, S. J. and Tang, W. 2015. Carbon stocks of mangroves within the Zambezi River Delta, Mozambique. *Forest Ecology Management* 354:139–148.

<b>Uncertainty associated with this parameter:</b>		
	<b>Forest type</b>	<b>Uncertainty estimate (confidence interval at 95%)</b>
	FSD	19.72%
	FSSV	18.33%
	FF	8.00%
<b>Any comment:</b>	-	

<b>Parameter:</b>	BGB <sub>before,j</sub>								
<b>Description:</b>	Belowground biomass of forest type <i>j</i> before conversion,								
<b>Data unit:</b>	tons of dry matter per ha								
<b>Source of data or description of the method for developing the data including the spatial level of the data (local, regional, national, international):</b>	<p>For semi-deciduous and evergreen forest, data are from the Zambézia Forest Inventory. It includes data that was collected in Zambézia province during the NFI, in 2017 and 2018. Please refer to parameter AGB<sub>before,j</sub> for more information.</p> <p>For mangrove forests, please refer to parameter AGB<sub>before,j</sub> for more information.</p> <p>Spatial level: Regional</p>								
<b>Value applied:</b>	<table border="1"> <tr> <td>Semi-deciduous forest (FSD)</td> <td>49.95</td> </tr> <tr> <td>Evergreen forest (FSSV)</td> <td>42.06</td> </tr> <tr> <td>Mangrove forest (FF)</td> <td>85.43</td> </tr> </table> <p>The values above are estimated and extracted in the workbook "<a href="#">Emission factor v.2</a>" and then they are recorded in the cells "B46", "B52" and "B58" respectively, of the "BIOMASS" worksheet tab in the "<a href="#">Outside ZILMP Emissions Calculations MR (2019)</a>" and "<a href="#">Outside ZILMP Emissions Calculations MR (2020)</a>" workbooks. These values are then applied in the range "E9:E20" of the "EMISSION MONITORING PERIOD(ERL)" worksheet tab in the "<a href="#">Outside ZILMP Emissions Calculations MR (2019)</a>" and "<a href="#">Outside ZILMP Emissions Calculations MR (2020)</a>" workbooks for estimating emissions.</p>	Semi-deciduous forest (FSD)	49.95	Evergreen forest (FSSV)	42.06	Mangrove forest (FF)	85.43		
Semi-deciduous forest (FSD)	49.95								
Evergreen forest (FSSV)	42.06								
Mangrove forest (FF)	85.43								
<b>QA/QC procedures applied</b>	Please see section QA/QC procedures under parameter AGB <sub>before,j</sub> .								
<b>Uncertainty associated with this parameter:</b>	<table border="1"> <tr> <td><b>Forest type</b></td> <td><b>Uncertainty estimate (confidence interval at 95%)</b></td> </tr> <tr> <td>FSD</td> <td>16.58%</td> </tr> <tr> <td>FSSV</td> <td>16.71%</td> </tr> <tr> <td>FF</td> <td>10.00%</td> </tr> </table>	<b>Forest type</b>	<b>Uncertainty estimate (confidence interval at 95%)</b>	FSD	16.58%	FSSV	16.71%	FF	10.00%
<b>Forest type</b>	<b>Uncertainty estimate (confidence interval at 95%)</b>								
FSD	16.58%								
FSSV	16.71%								
FF	10.00%								
<b>Any comment:</b>	-								

<b>Parameter:</b>	AGB <sub>after,i</sub>								
<b>Description:</b>	Aboveground biomass of non-forest type <i>i</i> after conversion								
<b>Data unit:</b>	tons of dry matter per ha								
<b>Source of data or description of the method for developing the data including the spatial level of the data (local, regional, national, international):</b>	<p>For cropland: The values and assumptions of 2006 IPCC GL, Volume 4, Chapter 5 are used because, unfortunately, there aren't country-specific data. The agricultural land in Mozambique is mostly under the annual-crop farming practices that drive conversion of forest land to agricultural lands. So, according to 2006 IPCC GL (Volume 4, Chapter 5, Section 5.28), for lands planted in annual crops, the default value of growth in crops planted after conversion is 5 tonnes of C per hectare, based on the original IPCC Guidelines recommendation of 10 tonnes of dry biomass per hectare (dry biomass has been converted to tonnes carbon in Table 5.9) (2006 IPCC, Volume 4, Chapter 5, Section 5.28).</p> <p>For grassland: The values and assumptions of 2006 IPCC GL, Volume 4, Chapter 6 are used because, unfortunately, there aren't country-specific data. As the climate in most of Mozambique is tropical dry to subtropical dry, the value of peak-above ground biomass for tropical dry of TABLE 6.4 is assumed.</p> <p>For other lands: No default values exist for these conversions.</p> <p>Spatial level: International</p>								
<b>Value applied:</b>	<table border="1" data-bbox="746 898 1086 999"> <tr> <td>Cropland (C)</td> <td>10</td> </tr> <tr> <td>Grassland (P)</td> <td>2.3</td> </tr> <tr> <td>Other lands (A O U)</td> <td>0.0</td> </tr> </table> <p>The values above are recorded in the ranges "B5:B9", "B11:B15" and "B17:B21" of the "BIOMASS" worksheet tab in the "<a href="#">Outside ZILMP Emissions Calculations MR (2019)</a>" and "<a href="#">Outside ZILMP Emissions Calculations MR (2020)</a>" workbook. These values are then applied in the range "D9:D20" of the "EMISSION MONITORING PERIOD(ERL)" worksheet tab in the "<a href="#">Outside ZILMP Emissions Calculations MR (2019)</a>" and "<a href="#">Outside ZILMP Emissions Calculations MR (2020)</a>" workbook for estimating emissions.</p>	Cropland (C)	10	Grassland (P)	2.3	Other lands (A O U)	0.0		
Cropland (C)	10								
Grassland (P)	2.3								
Other lands (A O U)	0.0								
<b>QA/QC procedures applied</b>	The adequacy in the use of these default values was confirmed with the experts in GHG Inventory in DINAB.								
<b>Uncertainty associated with this parameter:</b>	<table border="1" data-bbox="624 1357 1211 1603"> <thead> <tr> <th>Non-forest type</th> <th>Uncertainty estimate (confidence interval at 95%)</th> </tr> </thead> <tbody> <tr> <td>Cropland (C)</td> <td>75.00%</td> </tr> <tr> <td>Grassland (P)</td> <td>75.00%</td> </tr> <tr> <td>Other lands (A O U)</td> <td>-</td> </tr> </tbody> </table>	Non-forest type	Uncertainty estimate (confidence interval at 95%)	Cropland (C)	75.00%	Grassland (P)	75.00%	Other lands (A O U)	-
Non-forest type	Uncertainty estimate (confidence interval at 95%)								
Cropland (C)	75.00%								
Grassland (P)	75.00%								
Other lands (A O U)	-								
<b>Any comment:</b>	-								

<b>Parameter:</b>	BGB <sub>after,i</sub>
<b>Description:</b>	Belowground biomass of non-forest type <i>i</i> after conversion
<b>Data unit:</b>	tons of dry matter per ha
<b>Source of data or description of the method</b>	For cropland: The values and assumptions of 2006 IPCC GL, Volume 4, Chapter 5 are used because, unfortunately, there aren't country-specific data. Tier 2 may modify the assumption that carbon stocks immediately following conversion are zero. In this case, it is assumed that

<b>for developing the data including the spatial level of the data (local, regional, national, international):</b>	<p>conversion leads to annual croplands and in the case the carbon stock in biomass after one year for annual crops provided in TABLE 5.9 is used.</p> <p>For grassland: The values and assumptions of 2006 IPCC GL, Volume 4, Chapter 6, TABLE 6.1 and TABLE 6.4 are used because, unfortunately, there aren't country-specific data. As the climate in most of Mozambique is tropical dry to subtropical dry, the value for semi-arid grassland in tropical dry climate zone is used, therefore a root-shoot ratio of 2.8 (TABLE 6.1) is applied to the value of peak above-ground biomass, 2.3 tonnes of dry biomass per hectare (TABLE 6.4), generating the expected values 6.4 tonnes of dry biomass per hectare.</p> <p>For other lands: No default values exist for these conversions.</p> <p>Spatial level: International</p>								
<b>Value applied:</b>	<table border="1" style="margin-left: auto; margin-right: auto;"> <tr> <td style="background-color: #d9ead3;">Cropland (C)</td> <td style="text-align: center;">0.00</td> </tr> <tr> <td style="background-color: #d9ead3;">Grassland (P)</td> <td style="text-align: center;">6.44</td> </tr> <tr> <td style="background-color: #d9ead3;">Other lands (A O U)</td> <td style="text-align: center;">0.00</td> </tr> </table> <p>The values above are recorded in the ranges "B47:E51", "B53:B57" and "B59:B63" of the "BIOMASS" worksheet tab in the "<a href="#">Outside ZILMP Emissions Calculations MR (2019)</a>" and "<a href="#">Outside ZILMP Emissions Calculations MR (2020)</a>" workbooks. These values are then applied in the range "F9:F20" of the "EMISSION MONITORING PERIOD(ERL)" worksheet tab in the "<a href="#">Outside ZILMP Emissions Calculations MR (2019)</a>" and "<a href="#">Outside ZILMP Emissions Calculations MR (2020)</a>" workbooks for estimating emissions.</p>	Cropland (C)	0.00	Grassland (P)	6.44	Other lands (A O U)	0.00		
Cropland (C)	0.00								
Grassland (P)	6.44								
Other lands (A O U)	0.00								
<b>QA/QC procedures applied</b>	The adequacy in the use of these default values was confirmed with the experts in GHG Inventory in DINAB.								
<b>Uncertainty associated with this parameter:</b>	<table border="1" style="margin-left: auto; margin-right: auto;"> <thead> <tr> <th style="background-color: #d9ead3;">Non-forest type</th> <th style="background-color: #d9ead3;">Uncertainty estimate (confidence interval at 95%)</th> </tr> </thead> <tbody> <tr> <td style="background-color: #d9ead3;">Cropland (C)</td> <td style="text-align: center;">-</td> </tr> <tr> <td style="background-color: #d9ead3;">Grassland (P)</td> <td style="text-align: center;">121.04%</td> </tr> <tr> <td style="background-color: #d9ead3;">Other lands (A O U)</td> <td style="text-align: center;">-</td> </tr> </tbody> </table>	Non-forest type	Uncertainty estimate (confidence interval at 95%)	Cropland (C)	-	Grassland (P)	121.04%	Other lands (A O U)	-
Non-forest type	Uncertainty estimate (confidence interval at 95%)								
Cropland (C)	-								
Grassland (P)	121.04%								
Other lands (A O U)	-								
<b>Any comment:</b>	-								

### 1.1.6 Monitored Data and Parameters

<b>Parameter:</b>	A(j,i) <sub>MP</sub>			
<b>Description:</b>	Area converted from forest type <i>j</i> to non-forest type <i>i</i> during the Monitoring Period.			
<b>Data unit:</b>	hectare per year.			
<b>Value monitored during this Monitoring / Reporting Period:</b>	Type of change	2019	2020	Total
	Semi-deciduous forest to cropland	4,837.58	15,946.77	20,784.35
	Semi-deciduous forest to grassland	12.80	0.00	12.80
	Semi-deciduous forest to other lands	0.00	0.00	0.00
	Evergreen forest to cropland	867.21	2,568.30	3,435.51
	Evergreen forest to grassland	0.00	0.00	0.00
	Evergreen forest to other lands	0.00	0.00	0.00

	<table border="1"> <tr> <td>Mangrove forest to cropland</td> <td>0.00</td> <td>0.00</td> <td>0.00</td> </tr> <tr> <td>Mangrove forest to grassland</td> <td>0.00</td> <td>0.00</td> <td>0.00</td> </tr> <tr> <td>Mangrove forest to other lands</td> <td>0.00</td> <td>0.00</td> <td>0.00</td> </tr> </table>	Mangrove forest to cropland	0.00	0.00	0.00	Mangrove forest to grassland	0.00	0.00	0.00	Mangrove forest to other lands	0.00	0.00	0.00
Mangrove forest to cropland	0.00	0.00	0.00										
Mangrove forest to grassland	0.00	0.00	0.00										
Mangrove forest to other lands	0.00	0.00	0.00										
<b>Source of data and description of measurement/calculation methods and procedures applied:</b>	<p><b>(i) Source</b></p> <p>Activity data used for the monitoring period are obtained from a combination of an annual wall-to-wall deforestation map with sampling to generate deforested area estimates through a stratified estimator.</p> <p><b>(ii) Variable of interest</b></p> <p>The variable of interest are all the transitions specified above. It is important to note that the variables of interest are not aligned to the strata as this is not required. Strata is linked to the likelihood of presence of deforestation events, whereas the variable of interest is linked to the possible transitions of deforestation per forest type and post-deforestation type.</p> <p><b>(iii) Annual deforestation map</b></p> <p>The workflow used to produce annual deforestation map (2019 and 2020 separately) for the area outside the scope of ZILMP follows the steps below:</p> <ol style="list-style-type: none"> <li>1. Produce two Sentinel-2 satellite imagery composites for the monitoring area, containing all images of wet season (i.e. January - May). For 2019 deforestation map, the first composite comprises the period between January 2019 to May 2019 denoted as the reference period and the second composite comprises the period from January 2020 to May 2020, referred as actual period for 2019. For 2020 deforestation map, the first composites (reference period) comprises the period between January 2020 to May 2020 and November 2020the second composite (actual period) comprises the period from January 2021 to May 2021. The reason behind the selection of January - May as a reference and actual period of monitoring resides on the fact that it is the wet season, where the NDVI stability is very high in relation to the dry season, which starts in June to October, when most trees lose their foliage and makes it difficult the analysis of deforestation.</li> <li>2. Generate image features from reference period and actual period from the composites generated in previous step, to identify changes in forest cover. The image features have different vegetation indexes, namely, NDVI, EVI, SAVI, NBR, NDWI with respective sub-products such as NDVI 90th percentile, Normalized NDVI, and variation on NDVI.</li> <li>3. Generate training data on classes of deforestation, stable forest and stable non-forest by visual interpretation of composites from the reference and actual periods, and NDVI change detection image. The NDVI change detection image is a result of the difference of NDVI from the composites of reference and actual periods. The calculated NDVI change detection image helps the interpreter to locate where the changes of forest cover are occurring.</li> <li>4. Produce a categorical deforestation map from training data and image features through a process of classification using Random Forest classifier. The Categorical deforestation map includes non-forest stable and stable forest classes. Because errors of omission of deforestation have a very large impact on the final estimates, it is important to reduce these errors as much as possible.</li> <li>5. To improve the efficacy of the sampling the deforestation class on the map is reclassified as: <ol style="list-style-type: none"> <li>a) High probability deforestation (cluster of more than 10 pixels of deforestation, corresponding to at least 40% of one hectare);</li> </ol> </li> </ol>												

- b) Low probability of deforestation (cluster of less than 10 pixels and greater than 6 pixels, corresponding at least 24%- to 40% of one hectare) and;
  - c) Non-forest (cluster of less than 6 pixels, corresponding to less than 20% of a hectare).
6. To reduce the risk of omission errors, a Buffer of 40 meters is added around the high probability of deforestation class. The result is a deforestation map with five classes: High probability of deforestation; buffer; low probability of deforestation; stable forest and stable non-forest.

**(iv) Sampling design**

Sampling method

Monitoring of activity data for annual reporting is conducted using a stratified estimator, where deforestation map (which includes classes of forest and non-forest) is used for stratification and reference-sampling units are used for estimate activity data and associated confidence intervals.

Sample size determination

The sample size  $n$  was determined from the equation:

$$n = \frac{(\sum W_i S_i)^2}{[S(\hat{O})]^2 + \left(\frac{1}{N}\right) \sum W_i S_i} \approx \left(\frac{\sum W_i S_i}{S(\hat{O})}\right)^2 \quad \text{Equation 24}$$

Where:

- $N$  Number of units in the ROI
- $S(\hat{O})$  Standard error of the estimated overall accuracy that we would like to achieve
- $W_i$  Mapped proportion of area of class  $i$ ; and
- $S_i$  Standard deviation of stratum  $i$ .

The standard deviation of stratum  $i$  is given by the formula:

$$S_i = \sqrt{U_i(1 - U_i)} \quad \text{Equation 25}$$

Where:

- $U_i$  Proportion of area of deforestation in stratum  $i$ .

In order to obtain approximate values of proportion of deforestation in each stratum ( $U_i$ ), a pilot sampling is conducted. This pilot consists of 100 sample units per stratum.

Sample units per stratum

After the pilot sampling, sample units may need to be added to each stratum, in order to achieve 20% relative margin error at 95% confidence level. It was decided to use the Optimum (Neyman) allocation for each change stratum, where the stratum standard deviation  $S_i = \sqrt{U_i \cdot (1 - U_i)}$  increases the number of plots (ensuring larger numbers of plots in rare classes or strata) and sampling unit costs are constant:

$$n_i = n \frac{w_i \cdot S_i}{\sum_{i=1}^I w_i \cdot S_i}$$

**Equation 26**

And for each stable stratum, the proportional allocation is applied if deforestation omission errors are completely absent from these strata. In stratified sampling the sample size for proportional allocation is given by:

$$n_i = n \cdot w_i$$

**Equation 27**

The number of reference points is presented in Annex-Table 10.

*Annex-Table 10: Number of reference sampling units per map stratum for monitoring period (2019 and 2020)..*

Stratum	Number of sample units (2019)	Number of sample units (2020)
High probability of deforestation	100	100
40 m Buffer	100	100
Low probability of deforestation	100	100
Forest	100	100
Non-forest	100	100
<b>Total</b>	<b>500</b>	<b>500</b>

#### **(v) Response design**

##### Sampling unit and spatial support

The sampling unit is a 20 m pixel of the stratification map that was produced. The spatial support used is a 100m x 100m plot (1ha). Each Spatial sampling unit contains an internal grid of 5 x 5 points (20m x 20m grid) to aid in the labelling attribution (Annex-Figure 6).

##### Source of reference data

Each sampling unit was evaluated using Collect Earth (<http://www.openforis.org/>). This tool enables access to high-resolution images in Google Earth, Bing Maps and Planet Labs, as well as a medium resolution image repository available through Google Earth Engine Explorer and Code Editor (Landsat and Sentinel-2). The tool enables to display digital forms designed to collect the Land-Use Land Cover Change and Forestry (LULCCF) information on the sampling points (Annex-Figure 7). The Earth Engine Code Editor facilitates the interpretation of the vegetation type and the determination of LULC changes, by displaying the historical MOD13Q1 (NDVI 16-day Global Modis 250 m) graphic as well as monthly mosaics of Sentinel-2 images. The main source of data to identify changes in land cover, is Sentinel-2 15 days TOA reflectance composites. However, Planet data is also used in cases of doubt or excessive cloud cover with Sentinel-2.

##### Reference labelling protocol

The activity data was generated considering the national land use and land cover classification system, which reflects the six broad IPCC Land Use categories.

A set of hierarchical rules were established and used to determine the LULCCF category based on a certain percentage and taking into account the national forest definition as well (Annex-Figure 8). A single land use class is easier to classify, but it becomes challenging when there is a combination of two or more land use classes within the area of interest. Thus, this is where the hierarchical rules are important to determine the land use. Any sampling unit that has 30% of



tree canopy cover is considered a forest, according to the national forest definition, even if it has more than 20% of settlements, crops or other land use, the forest is priority.

In the case the sampling unit was classified as forest land and different forest types were present in the sampling unit, a majority rule was used in this case, i.e. the largest forest cover is considered as forest type within the plot.

**(vi) Analysis**

Applying the methodology described in Olofsson *et al.* (2014)<sup>31</sup> and the GFOI MGD the estimations of the areas corresponding to land-use and land-cover change categories, more specifically the activity data for deforestation, in the framework of this stratified random sampling approach (based on the visual assessment of the 1 ha plots) was based on assessments of area proportions. A sample error matrix is constructed where the map classes ( $h=1, 2, \dots, q$ ) are represented by rows and the reference data ( $k=1, 2, \dots, q$ ) by columns as shown in Annex-Table 11.

*Annex-Table 11: Error matrix of area proportions.*

Map data	Reference data					Total	User's accuracy ( $\hat{U}_i$ )
	Deforestation			Stable forest	Stable non-forest		
	High probability of deforestation	40 m Buffer	Low probability of deforestation				
High probability of deforestation	$\hat{p}_{11}$	$\hat{p}_{12}$	$\hat{p}_{13}$	$\hat{p}_{14}$	$\hat{p}_{15}$	$\hat{p}_{.1}$	$\hat{p}_{11}/\hat{p}_{.1}$
40 m Buffer	$\hat{p}_{21}$	$\hat{p}_{22}$	$\hat{p}_{23}$	$\hat{p}_{24}$	$\hat{p}_{25}$	$\hat{p}_{.2}$	$\hat{p}_{22}/\hat{p}_{.2}$
Low probability of deforestation	$\hat{p}_{31}$	$\hat{p}_{32}$	$\hat{p}_{33}$	$\hat{p}_{34}$	$\hat{p}_{35}$	$\hat{p}_{.3}$	$\hat{p}_{33}/\hat{p}_{.3}$
Stable forest	$\hat{p}_{41}$	$\hat{p}_{42}$	$\hat{p}_{43}$	$\hat{p}_{44}$	$\hat{p}_{45}$	$\hat{p}_{.4}$	$\hat{p}_{44}/\hat{p}_{.4}$
Stable non-forest	$\hat{p}_{51}$	$\hat{p}_{52}$	$\hat{p}_{53}$	$\hat{p}_{54}$	$\hat{p}_{55}$	$\hat{p}_{.5}$	$\hat{p}_{55}/\hat{p}_{.5}$
Total	$\hat{p}_{.1}$	$\hat{p}_{.2}$	$\hat{p}_{.3}$	$\hat{p}_{.4}$	$\hat{p}_{.5}$	$I$	
Producer's accuracy ( $P$ )	$\hat{p}_{11}/\hat{p}_{.1}$	$\hat{p}_{22}/\hat{p}_{.2}$	$\hat{p}_{33}/\hat{p}_{.3}$	$\hat{p}_{44}/\hat{p}_{.4}$	$\hat{p}_{55}/\hat{p}_{.5}$		Overall accuracy ( $\hat{O}$ ) $= \hat{p}_{11} + \hat{p}_{22} + \hat{p}_{33} + \hat{p}_{44} + \hat{p}_{55}$

The mean estimator for the area of each class can be directly obtained from the error matrix. Unbiased stratified estimators are provided using reference class area proportions ( $\hat{p}_{.k}$ ):

$$\hat{p}_{.k} = \sum_{h=1}^H w_h \cdot \frac{n_{hk}}{n_h} = \sum_{h=1}^H \hat{p}_{hk} \quad \text{Equation 28}$$

Where:

<sup>31</sup> Olofsson, P., Foody, G.M., Herold, M., Stehman, S.V., Woodcock, C.E., & Wulder, M.A. 2014. Good practices for estimating area and assessing accuracy of land change. *Remote Sensing of Environment*. 148:42-57.

	<p><math>\hat{p}_{\cdot k}</math> Area proportions of reference data class <math>k</math>. These proportions of reference data for deforestation classes as a whole are collapsed in three possible types of conversions/transitions from forest type <math>j</math> to non-forest type <math>i</math>, namely:</p> <ul style="list-style-type: none"> <li>• Broadleaved (Semi-) deciduous to Non-forest type <math>i</math>;</li> <li>• Broadleaved (Semi-) evergreen to Non-forest type <math>i</math>; and</li> <li>• Mangrove to Non-forest type <math>i</math>.</li> </ul> <p>Five types of non-forest land are considered:</p> <ul style="list-style-type: none"> <li>• Cropland (C);</li> <li>• Grassland (P);</li> <li>• Wetland (A);</li> <li>• Settlement (U); and</li> <li>• Other lands (O).</li> </ul> <p><math>w_h</math> Proportion of area mapped as class <math>h</math>;</p> <p><math>n_{hk}</math> Sample count at cell <math>(h,k)</math>;</p> <p><math>n_{h\cdot}</math> Sum of sample counts across row <math>h</math>; and</p> <p><math>\hat{p}_{hk}</math> Proportion of area in cell <math>(h,k)</math>.</p> <p>Once the estimated reference class area proportions (<math>\hat{p}_{\cdot k}</math>) are obtained, the mean total area per class is calculated by multiplying them with the total reporting area <math>a</math>:</p> $\hat{A}_j = \hat{p}_{\cdot k} \cdot a \quad \text{Equation 29}$ <p>The estimated standard error for the reference class area proportions was given by:</p> $S(\hat{p}_{\cdot j}) = \sqrt{\sum_{h=1}^H w_h^2 \cdot \frac{\hat{p}_{hj} \cdot (1 - \hat{p}_{hj})}{n_{h\cdot} - 1}} \quad \text{Equation 30}$ <p>where the term inside the root is the variance of the reference class area proportion. Translated to actual area,</p> $S(\hat{A}_j) = S(\hat{p}_{\cdot j}) \cdot a \quad \text{Equation 31}$ <p>Given the confidence level (i.e., 95%, expressed as a fraction, that is, 0.95), the significance level is <math>\alpha = 1 - \text{confidence level}</math>, one must use Student's <math>t</math> given <math>\alpha</math> and the degrees of freedom, <math>df = n_{h\cdot} - 1</math>. For large samples, <math>df \rightarrow 1.96</math>. Then the confidence interval of the estimated area per class was given by:</p> $CI(\hat{A}_j) = t_{\alpha, df} \cdot S(\hat{p}_{\cdot j}) \quad \text{Equation 32}$ <p>The uncertainty, usually represented as a percentage, then becomes:</p> $U(\hat{A}_j) = \frac{CI(\hat{A}_j)}{\hat{A}_j} \cdot 100 \quad \text{Equation 33}$
<p><b>QA/QC procedures applied:</b></p>	<p>The QA/QC procedures consisted on the following:</p> <ul style="list-style-type: none"> <li>• SOPs were developed as described in <a href="#">Section 2.1 - Satellite and land monitoring system and training</a>; and</li> <li>• Interpretation is done by highly qualified professionals which are specialized in land cover interpretation with satellite imagery. They were trained and a robust control</li> </ul>

	<p>system is in place to ensure that they are correctly calibrated throughout the data collection process.</p> <ul style="list-style-type: none"> <li>• All reference data interpreted as deforestation, and an additional 20% of the remaining reference data were evaluated. The quality control is carried out by two independent supervisors, who after the independent evaluation compare the two evaluations and consensually compile a single comment for each sample. The parameters to be taken into account in the evaluation for identifying errors are: a) the percentage of coverage for each element within the plot; b) the current land cover/land use class (levels 1 and 2); c) the land cover/land use change class; d) the former land cover/land use class (levels 1 and 2); and e) the date of occurrence of land cover/land use change, or evidence date of remaining land cover/land use. If there are gross errors related to the parameters b), c) and d) in at least 20% of samples from the 20% mentioned initially, the respective interpreter should review all samples from the batch, otherwise the interpreter reviews only the samples evaluated by the supervisors, that present gross errors. On the other hand, in relation to all samples interpreted as deforestation, the interpreter reviews only the samples that present gross errors according to the evaluation from the supervisors. The process is cyclical until the interpreter achieves values less than 20% of gross errors in the batch.</li> <li>• The sampling design and estimation was reviewed by an international renowned expert (Steve Stehman), a statistics professor of State University of New York.</li> </ul>														
<p><b>Uncertainty for this parameter:</b></p>	<table border="1" data-bbox="517 916 1399 1135"> <thead> <tr> <th rowspan="2">Category change</th> <th colspan="2">Uncertainty estimate (Confidence interval at 95%)</th> </tr> <tr> <th>2019</th> <th>2020</th> </tr> </thead> <tbody> <tr> <td>FSD&gt;C</td> <td>20.11%</td> <td>17.33%</td> </tr> <tr> <td>FSD&gt;P</td> <td>196.48%</td> <td></td> </tr> <tr> <td>FSSV&gt;C</td> <td>59.23%</td> <td>50.70%</td> </tr> </tbody> </table>	Category change	Uncertainty estimate (Confidence interval at 95%)		2019	2020	FSD>C	20.11%	17.33%	FSD>P	196.48%		FSSV>C	59.23%	50.70%
Category change	Uncertainty estimate (Confidence interval at 95%)														
	2019	2020													
FSD>C	20.11%	17.33%													
FSD>P	196.48%														
FSSV>C	59.23%	50.70%													
<p><b>Any comment:</b></p>	<p>-</p>														

## 5.4 QUANTIFICATION OF EMISSION REDUCTIONS

### 5.4.1 Reference level for the Monitoring / Reporting Period covered in this report

Year of Monitoring/Reporting period $t$	Average annual historical emissions from deforestation over the Reference Period (tCO <sub>2</sub> -e/yr)	If applicable, average annual historical emissions from forest degradation over the Reference Period (tCO <sub>2</sub> -e/yr)	If applicable, average annual historical removals by sinks over the Reference Period (tCO <sub>2</sub> -e/yr)	Adjustment, if applicable (tCO <sub>2</sub> -e/yr)	Reference level (tCO <sub>2</sub> -e/yr)
2019	7,932,644.34	-	-	-	7,932,644.34
2020	7,932,644.34				7,932,644.34
<b>Total</b>	<b>15,865,288.68</b>	-	-	-	<b>15,865,288.68</b>

### 5.4.2 Estimation of emissions by sources and removals by sinks included

The following table shows the emissions results obtained per category changes from a forest type to a non-forest type during the Monitoring Period. The emissions are generated relating the data and parameters described in [Subsection 5.3.2](#) and summarized in the Annex-Table 12, by applying [Equation 14](#).

Annex-Table 12: Calculation of the emissions during the Monitoring Period.

Category changes	AGB <sub>before,j</sub> (tdm/ha)	BGB <sub>before,j</sub> (tdm/ha)	AGB <sub>after,i</sub> (tdm/ha)	BGB <sub>after,i</sub> (tdm/ha)	Year of Monitoring/Reporting Period			
					2019		2020	
					A <sub>(j,i)MP</sub> (ha)	Emissions (tCO <sub>2</sub> e)	A <sub>(j,i)MP</sub> (ha)	Emissions (tCO <sub>2</sub> e)
Semi-deciduous forest to cropland	144.69	49.95	10.00	0.00	4,837.58	1,539,260.21	15,946.77	5,074,071.90
Semi-deciduous forest to grassland	144.69	49.95	2.30	6.40	12.80	4,100.98	0.00	0.00
Semi-deciduous forest to other lands	144.69	49.95	0.00	0.00	0.00	0.00	0.00	0.00
Evergreen forest to cropland	123.13	42.06	10.00	0.00	867.21	231,927.06	2,568.30	686,864.57

Evergreen forest to grassland	123.13	42.06	2.30	6.40	0.00	0.00	0.00	0.00
Evergreen forest to other lands	123.13	42.06	0.00	0.00	0.00	0.00	0.00	0.00
Mangrove to cropland	269.01	85.43	10.00	0.00	0.00	0.00	0.00	0.00
Mangrove to grassland	269.01	85.43	2.30	6.40	0.00	0.00	0.00	0.00
Mangrove to other lands	269.01	85.43	0.00	0.00	0.00	0.00	0.00	0.00
<b>Total</b>						<b>1,775,288.26</b>		<b>5,760,936.47</b>

Year of Monitoring/Reporting Period	Emissions from deforestation (tCO <sub>2</sub> -e/yr)	If applicable, emissions from forest degradation (tCO <sub>2</sub> -e/yr)*	If applicable, removals by sinks (tCO <sub>2</sub> -e/yr)	Net emissions and removals (tCO <sub>2</sub> -e/yr)
2019	1,775,288.26	-	-	1,775,288.26
2020	5,760,936.47			5,760,936.47
<b>Total</b>	7,536,224.72	-	-	<b>7,536,224.72</b>

#### 5.4.3 Calculation of emission reductions

<b>Total Reference Level emissions during the Reporting Period (tCO<sub>2</sub>-e)</b>		7,932,644.34
<b>Net emissions and removals under the ER Program during the Reporting Period (tCO<sub>2</sub>-e)</b>	<b>2019</b>	1,775,288.26
	<b>2020</b>	5,760,936.47
<b>Emission Reductions during the Reporting Period (tCO<sub>2</sub>-e)</b>	<b>2019</b>	6,157,356.08
	<b>2020</b>	2,171,707.88

## 5.5 UNCERTAINTY OF THE ESTIMATE OF EMISSION REDUCTIONS

Uncertainties were propagated using the Approach 1 of the 2019 Refinement to the 2006 IPCC GL, i.e. propagation of uncertainties. The following equations were used for addition or multiplication.

For addition or subtraction:

$$U_{total} = \frac{\sqrt{(U_1 \cdot x_1)^2 + \dots + (U_i \cdot x_i)^2 + \dots + (U_n \cdot x_n)^2}}{|x_1 + \dots + x_i + \dots + x_n|} \quad \text{Equation 34}$$

Where:

$U_i$	The percentage uncertainties associated with each of the quantities;
$X_i$	Quantities to be combined; $x_i$ may be a positive or a negative number; and
$U_{total}$	The percentage uncertainty in the sum of the quantities (half the 95 percent confidence interval divided by the total (i.e., mean) and expressed as a percentage)

For multiplication:

$$U_{total} = \sqrt{U_1^2 + \dots + U_i^2 + \dots + U_n^2} \quad \text{Equation 35}$$

Where:

$X_i$	The percentage uncertainties associated with each of the quantities; and
$U_{total}$	The percentage uncertainty in the product of the quantities (half the 95 percent confidence interval divided by the total and expressed as a percentage)

<b>Uncertainty of Reference Level emissions during the Monitoring Period (%)</b>		19.34
<b>Uncertainty of net emissions and removals under the ER Program during the Monitoring Period (%)</b>	<b>2019</b>	23.99
	<b>2020</b>	22.07
<b>Uncertainty of Emission Reductions during the Reporting Period (%)</b>	<b>2019</b>	25.85
	<b>2020</b>	91.74